

Fresh air from

ÖSTBERG
THE FAN COMPANY 

RK/RKB

Rectangular duct fans



Contents

RECTANGULAR DUCT FANS5

HOW TO CHOOSE THE RIGHT FAN6

RK 400 x 200 C1	8
RK 400 x 200 C3	8
RK 500 x 250 B1	9
RK 500 x 250 D1	9
RK 500 x 250 D3	10
RK 500 x 300 A1	10
RK 500 x 300 B1	11
RK 500 x 300 B3	11
RK 600 x 300 D1	12
RK 600 x 300 D3	12
RK 600 x 300 F1	13
RK 600 x 300 F3	13
RK 600 x 350 C1	14
RK 600 x 350 C3	14
RK 600 x 350 E1	15
RK 600 x 350 E3	15
RK 700 x 400 A3	16
RK 700 x 400 B3	16
RK 700 x 400 D3	17
RK 800 x 500 C3	17
RK 800 x 500 E3	18
RK 800 x 500 F3	18
RK 1000 x 500 G3	19
RK 1000 x 500 H3	19

RKB 300 x 150 C1	20
RKB 400 x 200 A1	20
RKB 400 x 200 B1	21
RKB 400 x 200 E1	21
RKB 500 x 250 A1	22
RKB 500 x 250 C1	22
RKB 500 x 250 E1	23
RKB 600 x 300 A1	23
RKB 600 x 300 B1	24
RKB 600 x 300 G1	24
RKB 600 x 350 A1	25
RKB 600 x 350 B1	25
RKB 600 x 350 B3	26
RKB 600 x 350 D1	26
RKB 600 x 350 D3	27
RKB 700 x 400 C1	27
RKB 700 x 400 C3	28
RKB 700 x 400 E1	28
RKB 700 x 400 E3	29
RKB 800 x 500 B1	29
RKB 800 x 500 B3	30
RKB 800 x 500 D3	30
RKB 800 x 500 K1	31
RKB 800 x 500 K3	31
RKB 1000 x 500 J1	32
RKB 1000 x 500 J3	32
RKB 1000 x 500 L3	33

GENERAL FAN FACTS34-35

A NEW GENERATION OF DUCT FANS

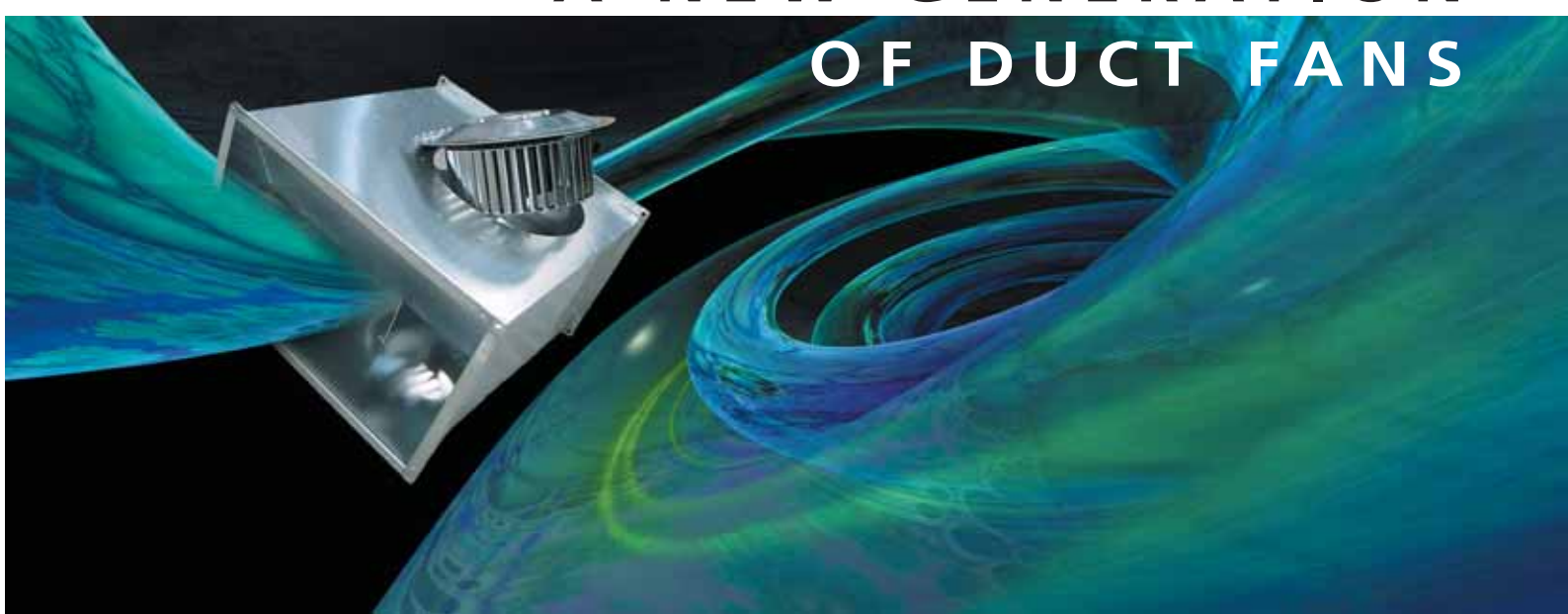

Another revolutionary invention

As a follow-on from the in-line circular duct fan, Hans Östberg invented in the middle of the 70's the rectangular in-line duct fan, using an in external rotor motor but having a straight-through airflow (registered design no. 32838).

Thanks to the 90° angle of the airflow on the inlet side, the casing height is only a couple of centimetres more than the duct dimensions.

All rectangular in-line duct fans from AB C.A. Östberg have swing-out motor and impeller assemblies for ease of maintenance and cleaning.

We at AB C.A. Östberg are committed to giving everyone the opportunity of a better indoor climate. Our products do this by extracting the stale air and replacing it with clean air.

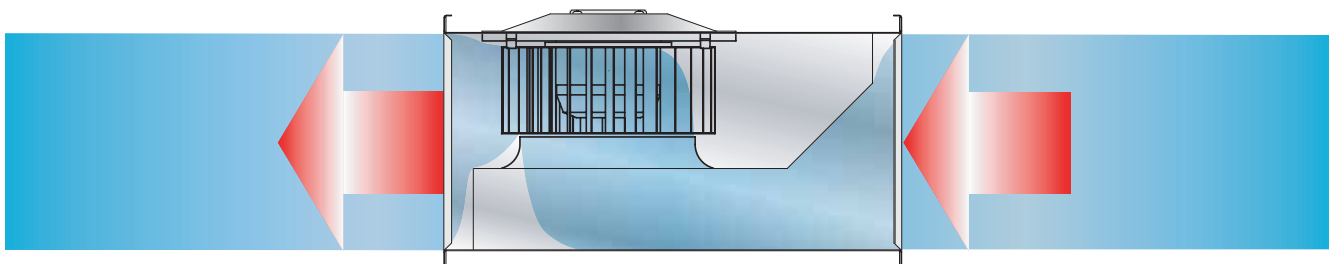

Key to model type

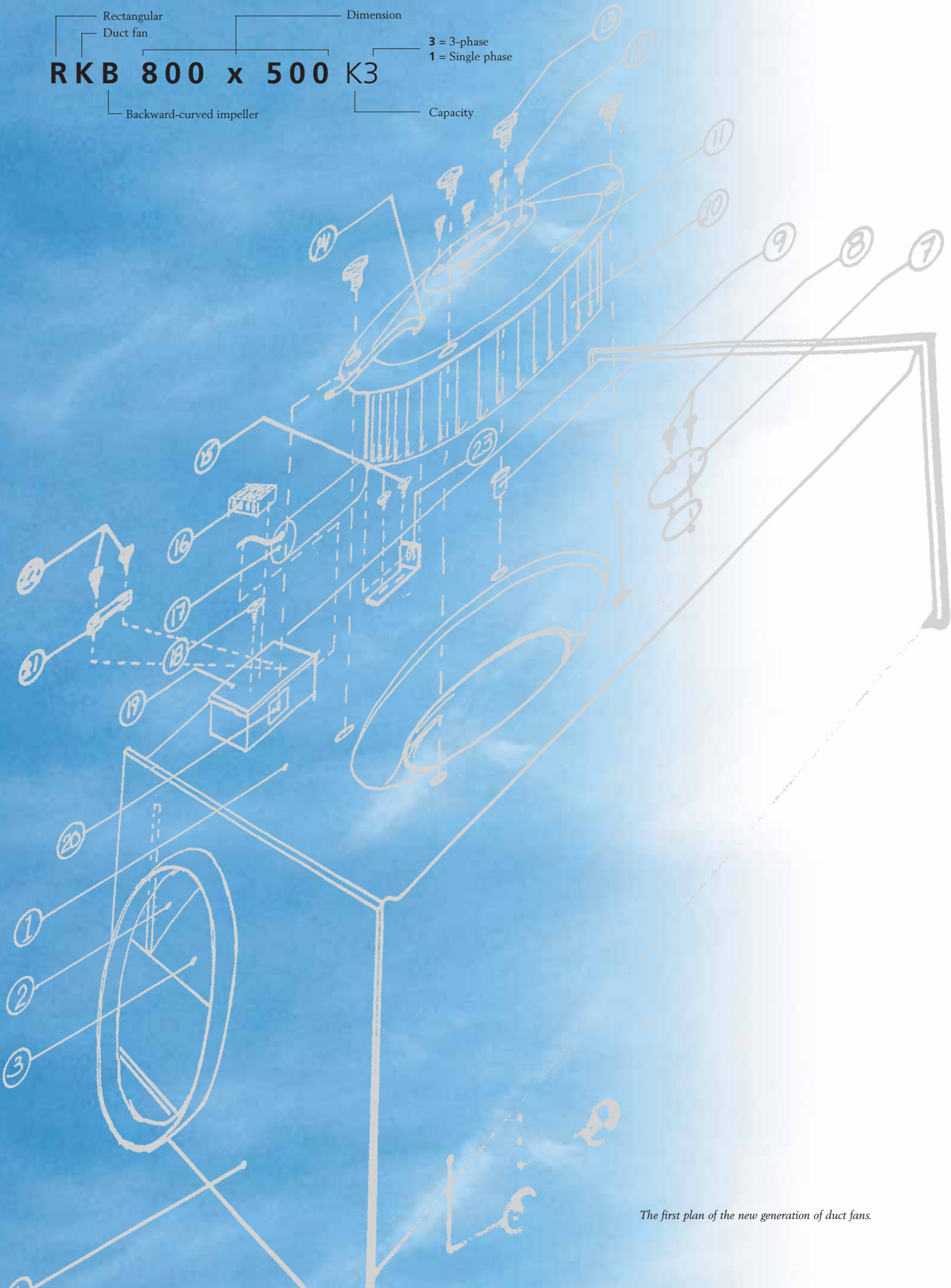
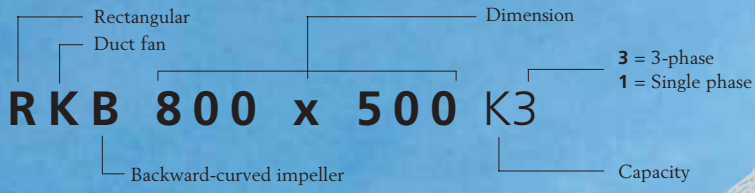

The first plan of the new generation of duct fans.



RK/RKB Rectangular in-line duct fans

RK and RKB are in-line centrifugal duct fans with flanges for connection to rectangular ducting. The fans have a sturdy casing of galvanized sheet steel. They are compact, have a high capacity, possess low sound levels and can be installed in any position.

The RK fan has a forward curved impeller and is available in 24 different versions. The RKB fan has a backward curved impeller and 27 versions are available.

These fans are designed to cope with high pressures and overcome long ducts and to give low sound levels. The motors are high quality external rotor motors, suitable for stepless speed variation and are virtually maintenance free. The only service task required is cleaning the impeller.

The impeller and motor assembly can be swung out for easy cleaning and safe inspections. All fans are supplied fully wired to an external

terminal box. They are moisture proof and can be used for outdoor applications. All fans have built-in thermal protection.

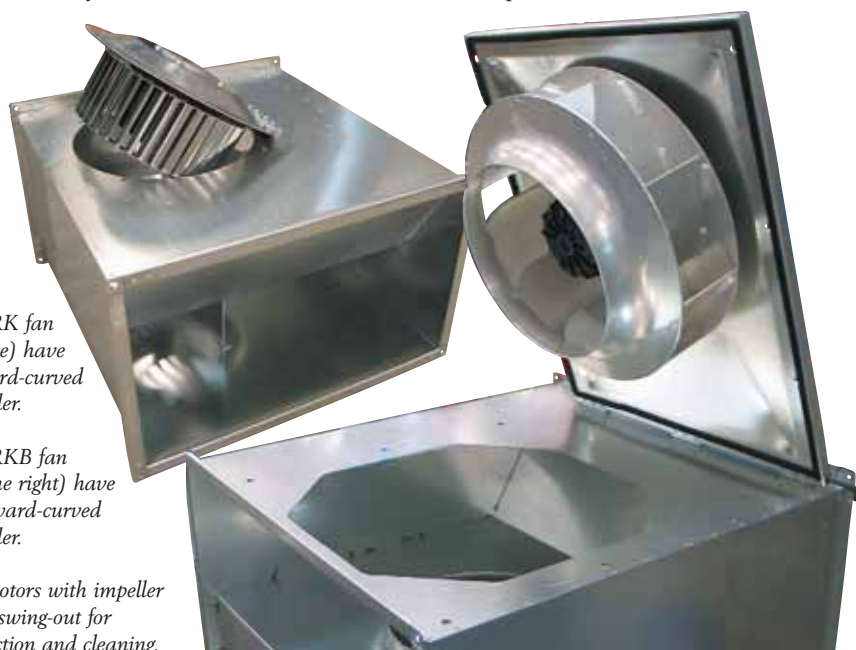

The RK fan (above) have forward-curved impeller.

The RKB fan (on the right) have backward-curved impeller.

All motors with impeller have swing-out for inspection and cleaning.

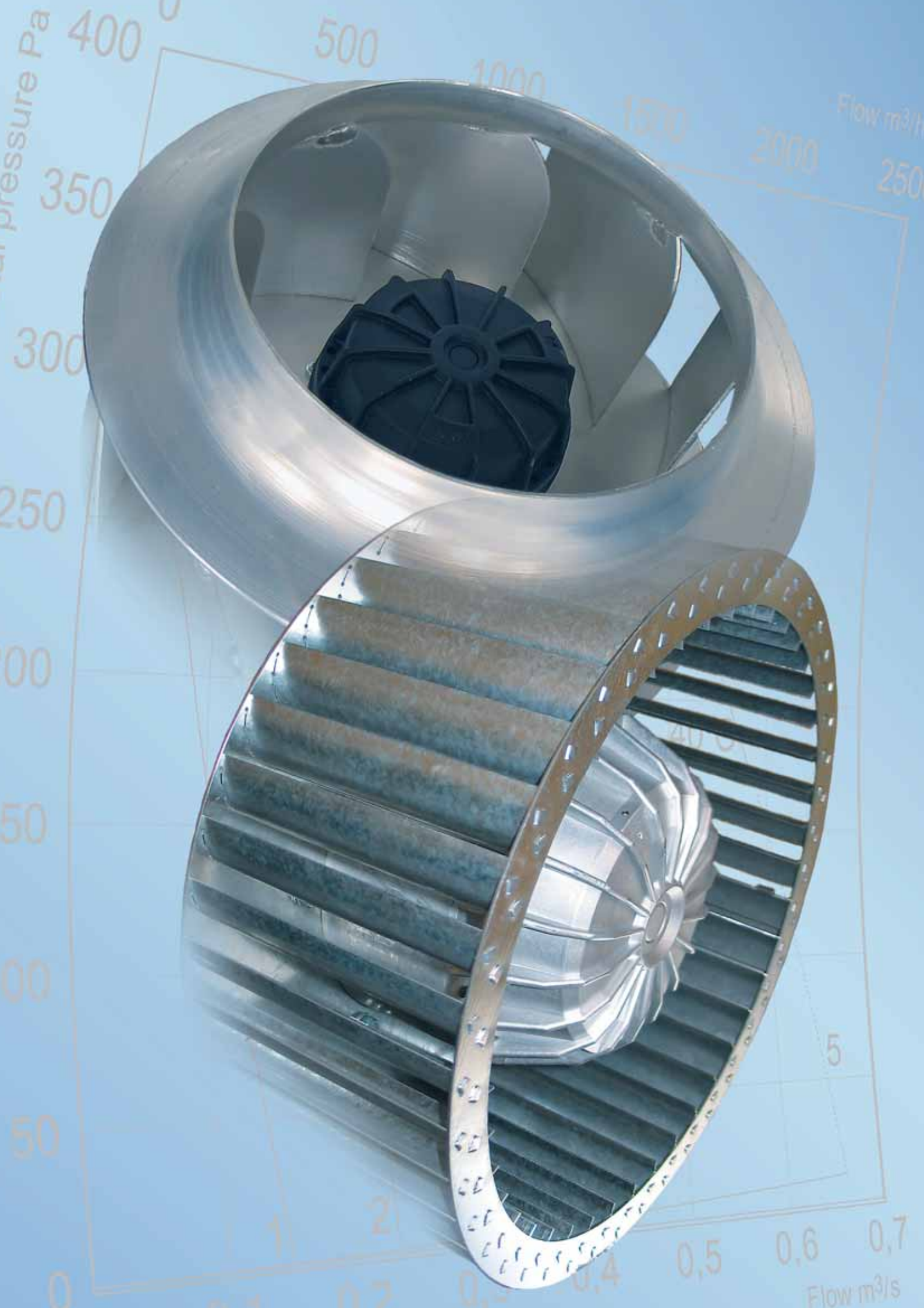

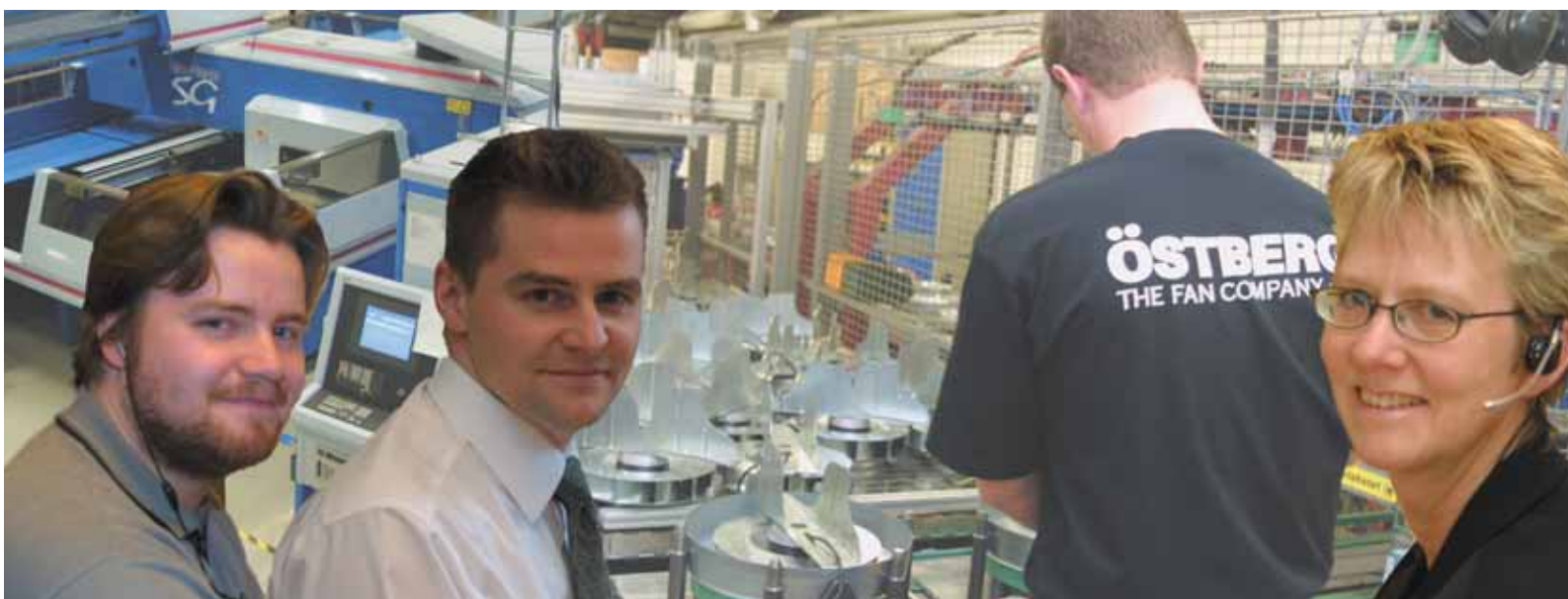

How to choose the right fan

Our staff has the knowledge and the experience to help our customers to select the right fan for the right application.

When choosing a fan there are many aspects to consider and some basic knowledge of ventilation systems is required. A ventilation system can consist of a fan with or without ductwork attached. If the system has ductwork it often also has filters, silencers, dampers, grilles etc. All of these components contribute to the performance of the system regarding sound level, pressure drop and air-flow.

You have to know the air volume and the pressure, where the fan can be installed and then choose the fan type, also considering efficiency, sound level and price.

RK OR RKB

RK with its forward curved impeller is very compact and very competitive at the best working area i.e. high pressure.

RKB with its backward curved

impeller has a very good efficiency over a wide working area. But the RKB has a slightly larger casing. Due to larger impeller blades it is very easy to clean and is very competitively priced.

TOTAL PRESSURE

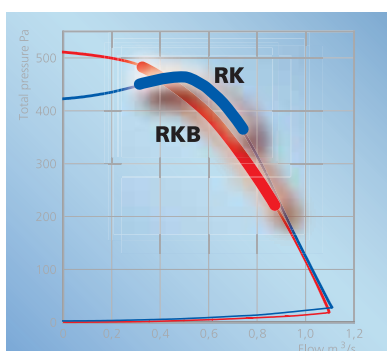

TOTAL EFFICIENCY

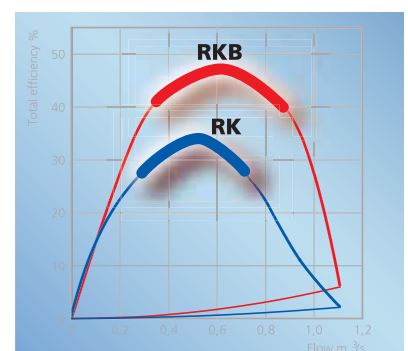

When comparing RK and RKB at corresponding flow and pressure, the diagrams shown that RK has a higher pressure and RKB gives a better efficiency

RK 400 x 200 C1

RK 400 x 200 C3

With forward-curved impeller and swing-out design



RK 400 x 200 C1

PRESSURE/FLOW

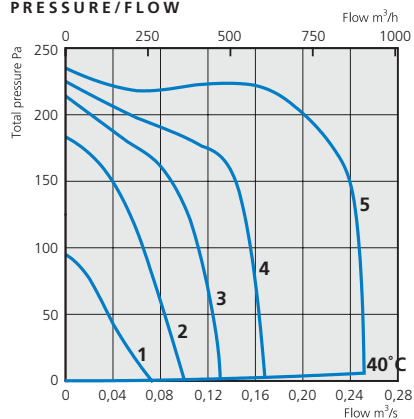

INPUT/FLOW

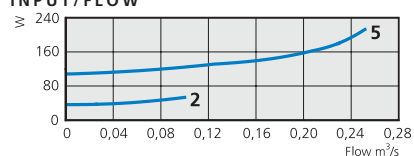

TECHNICAL DATA

Voltage, V/Hz	230/50
Current, A	0,95
Input, W	215
Speed, rpm	815
Weight, kg	11
Wiring diagram	4040001
Capacitor, μ F	6
Insulation class	F
Motor protection	IP 44

DIMENSIONS (mm)

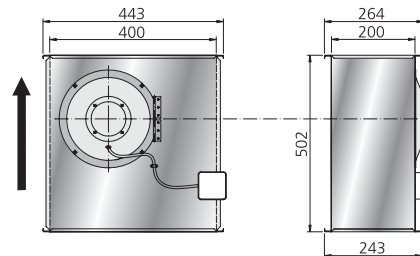

SOUND DATA

195 l/s 205 PaTot	L_{pA}	L_{wA} tot dB (A)	63	125	250	500	1K	2K	4K	8K
To environment 230 V	50	57	36	46	52	50	52	45	40	32
5. Inlet 230 V		69	58	64	64	61	55	56	54	47
4. Inlet 165 V		64	55	59	59	55	50	51	48	39
3. Inlet 135 V		62	54	57	57	53	47	48	44	34
2. Inlet 110 V		60	53	55	55	52	44	46	40	31
1. Inlet 80 V		53	47	47	48	47	39	38	31	20
Outlet 230 V		72	61	63	65	65	64	63	62	55

General fan facts, page 34-35.

RK 400 x 200 C3

PRESSURE/FLOW

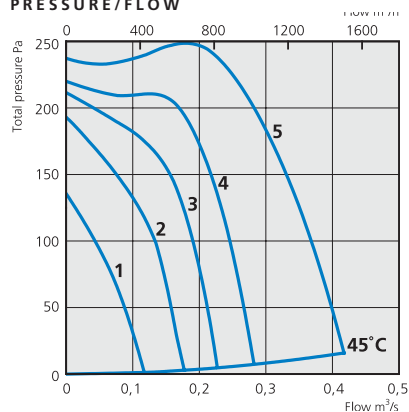

INPUT/FLOW

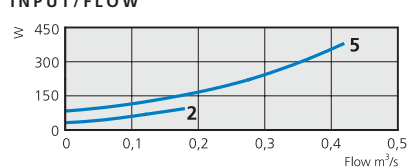

TECHNICAL DATA

Voltage, V/Hz	400/50
Current, A	0,65
Input, W	375
Speed, rpm	1185
Weight, kg	13
Wiring diagram	4040004
Capacitor, μ F	-
Insulation class	F
Motor protection	IP 44

DIMENSIONS (mm)

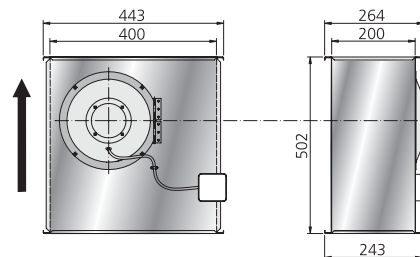

SOUND DATA

243 l/s 230 PaTot	L_{pA}	L_{wA} tot dB (A)	63	125	250	500	1K	2K	4K	8K
To environment 400 V	545	62	39	52	54	56	56	51	46	39
5. Inlet 400 V		73	61	68	69	66	60	60	59	54
4. Inlet 240 V		67	58	63	62	58	53	54	52	46
3. Inlet 185 V		65	57	60	60	56	50	52	49	42
2. Inlet 145 V		63	55	57	57	54	48	49	46	38
1. Inlet 95 V		58	51	53	53	50	41	42	37	26
Outlet 400 V		79	67	69	73	72	71	70	70	66

General fan facts, page 34-35.



RK 500 x 250 B1 RK 500 x 250 D1

With forward-curved impeller and swing-out design

RK 500 x 250 B1

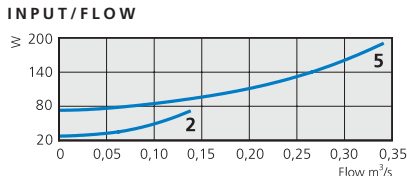
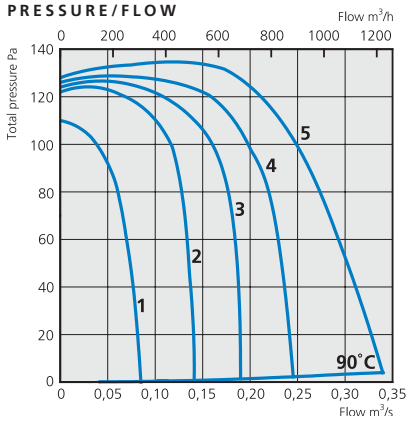

TECHNICAL DATA

Voltage, V/Hz	230/50
Current, A	0,89
Input, W	190
Speed, rpm	822
Weight, kg	16
Wiring diagram	4040005
Capacitor, μ F	3
Insulation class	F
Motor protection	IP 44

DIMENSIONS (mm)

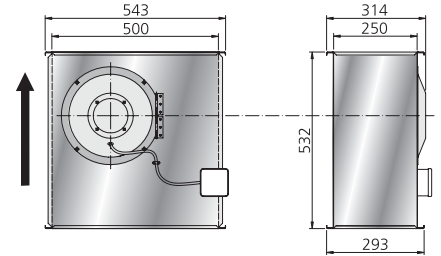

SOUND DATA

190 l/s 127 PaTot	L_{pA}	L_{wA} tot dB (A)	63	125	250	500	1K	2K	4K	8K
To environment 230 V	47	54	31	39	47	48	48	45	42	35
5. Inlet 230 V		64	53	56	57	54	54	57	55	45
4. Inlet 165 V		62	52	54	56	53	52	55	53	43
3. Inlet 135 V		60	51	52	54	52	50	53	50	39
2. Inlet 110 V		55	45	47	49	48	44	48	43	31
1. Inlet 80 V		43	34	37	39	35	31	31	22	12
Outlet 230 V		71	56	57	60	65	65	64	63	55

General fan facts, page 34-35.

RK 500 x 250 D1

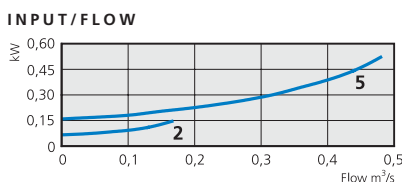
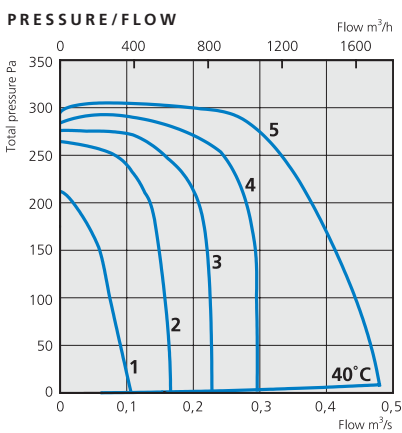

TECHNICAL DATA

Voltage, V/Hz	230/50
Current, A	2,41
Input, kW	0,52
Speed, rpm	1110
Weight, kg	17
Wiring diagram	4040005
Capacitor, μ F	8
Insulation class	F
Motor protection	IP 44

DIMENSIONS (mm)

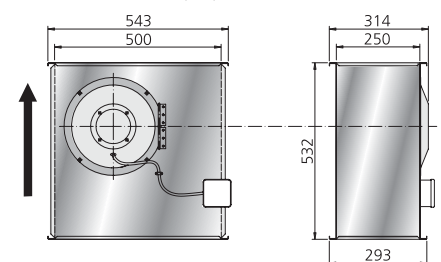

SOUND DATA

247 l/s 295 PaTot	L_{pA}	L_{wA} tot dB (A)	63	125	250	500	1K	2K	4K	8K
To environment 230 V	56	63	39	48	57	55	57	54	51	48
5. Inlet 230 V		74	61	68	67	61	63	66	64	59
4. Inlet 165 V		71	60	63	65	60	61	64	63	56
3. Inlet 135 V		69	57	65	62	57	58	61	60	52
2. Inlet 110 V		66	53	65	57	53	52	55	52	42
1. Inlet 80 V		59	40	59	45	42	38	39	32	19
Outlet 230 V		80	61	65	68	71	75	73	72	68

General fan facts, page 34-35.

RK 500 x 250 D3

RK 500 x 300 A1

With forward-curved impeller and swing-out design



RK 500 x 250 D3

PRESSURE/FLOW

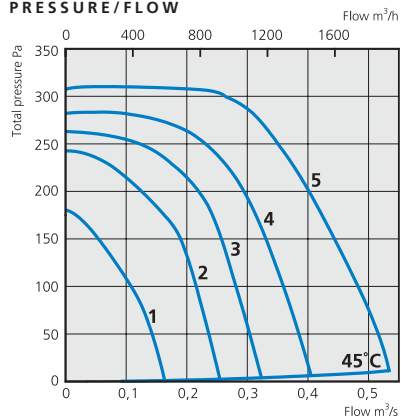

INPUT/FLOW

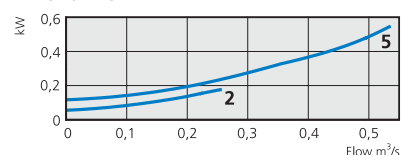

TECHNICAL DATA

Voltage, V/Hz	400/50
Current, A	0,93
Input, kW	0,54
Speed, rpm	1270
Weight, kg	17
Wiring diagram	4040004
Capacitor, μ F	-
Insulation class	F
Motor protection	IP 44

DIMENSIONS (mm)

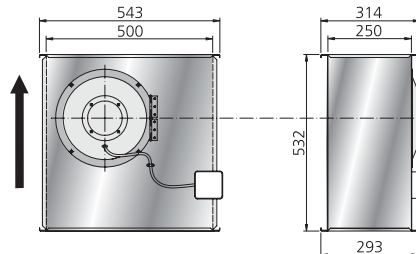

SOUND DATA

262 l/s 300 PaTot	L_{pA}	L_{wA}	tot dB (A)	63	125	250	500	1K	2K	4K	8K
To environment 400 V	56	63	63	40	47	56	56	57	55	51	44
5. Inlet 400 V		72	60	64	66	62	63	65	64	64	58
4. Inlet 240 V		69	58	61	62	58	59	62	60	60	54
3. Inlet 185 V		67	57	59	60	57	57	60	58	58	50
2. Inlet 145 V		65	56	58	58	55	54	57	54	54	46
1. Inlet 95 V		58	49	51	51	50	47	50	46	46	35
Outlet 400 V	78	59	63	66	69	73	72	71	65	65	65

General fan facts, page 34-35.

RK 500 x 300 A1

PRESSURE/FLOW

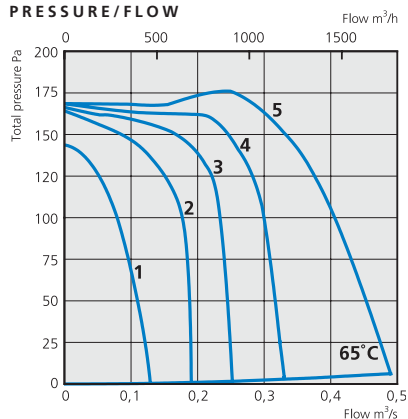

INPUT/FLOW

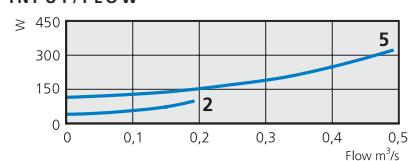

TECHNICAL DATA

Voltage, V/Hz	230/50
Current, A	1,45
Input, W	320
Speed, rpm	765
Weight, kg	19
Wiring diagram	4040005
Capacitor, μ F	5
Insulation class	F
Motor protection	IP 44

DIMENSIONS (mm)

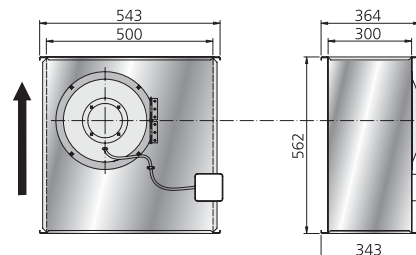

SOUND DATA

249 l/s 176 PaTot	L_{pA}	L_{wA}	tot dB (A)	63	125	250	500	1K	2K	4K	8K
To environment 230 V	49	56	33	48	53	48	43	39	37	30	30
5. Inlet 230 V		66	58	59	59	55	56	59	57	48	48
4. Inlet 165 V		63	56	57	55	53	53	55	53	43	43
3. Inlet 135 V		62	54	57	53	52	51	54	51	40	40
2. Inlet 110 V		60	54	55	53	50	48	50	46	35	35
1. Inlet 80 V		57	50	53	49	46	44	46	39	28	28
Outlet 230 V	70	57	61	60	63	63	61	61	61	52	52

General fan facts, page 34-35.



RK 500 x 300 B1 RK 500 x 300 B3

With forward-curved impeller and swing-out design

RK 500 x 300 B1

PRESSURE/FLOW

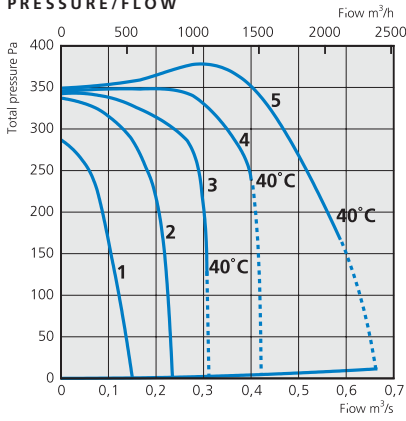

INPUT/FLOW

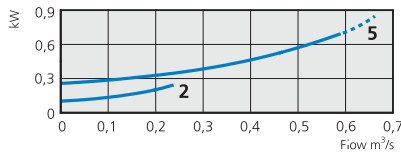

TECHNICAL DATA

Voltage, V/Hz	230/50
Current, A	3,25
Input, kW	0,69
Speed, rpm	1275
Weight, kg	21
Wiring diagram	4040005
Capacitor, µF	12
Insulation class	F
Motor protection	IP 44

DIMENSIONS (mm)

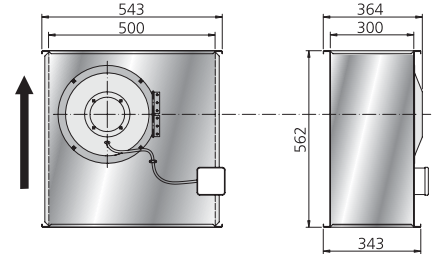

SOUND DATA

373 l/s 365 PaTot	L _{pA}	L _{wA} tot dB (A)	63	125	250	500	1K	2K	4K	8K
To environment 230 V	55	62	35	47	58	57	56	51	46	38
5. Inlet 230 V		77	64	70	73	61	65	68	66	61
4. Inlet 165 V		72	63	66	65	58	61	65	63	56
3. Inlet 135 V		71	63	64	63	57	59	63	61	54
2. Inlet 110 V		68	60	62	60	55	57	60	58	50
1. Inlet 80 V		63	56	57	57	51	50	54	50	40
Outlet 230 V		79	65	67	72	69	74	72	72	66

General fan facts, page 34-35.

RK 500 x 300 B3

PRESSURE/FLOW

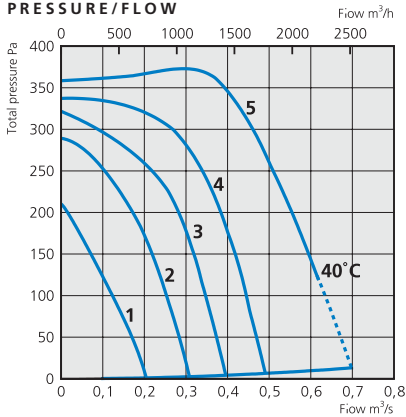

INPUT/FLOW

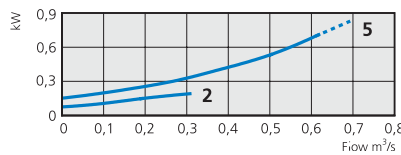

TECHNICAL DATA

Voltage, V/Hz	400/50
Current, A	1,45
Input, kW	0,72
Speed, rpm	1260
Weight, kg	21
Wiring diagram	4040004
Capacitor, µF	-
Insulation class	F
Motor protection	IP 44

DIMENSIONS (mm)

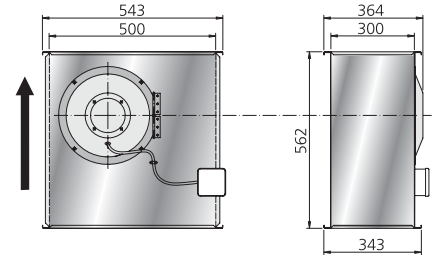

SOUND DATA

469 l/s 295 PaTot	L _{pA}	L _{wA} tot dB (A)	63	125	250	500	1K	2K	4K	8K
To environment 400 V	55	62	37	48	56	54	57	54	52	45
5. Inlet 400 V		76	66	69	68	63	67	70	68	63
4. Inlet 240 V		73	64	66	65	61	63	66	64	59
3. Inlet 185 V		69	61	62	60	57	59	62	60	53
2. Inlet 145 V		65	58	58	57	54	55	58	56	47
1. Inlet 95 V		58	52	51	50	49	46	49	44	36
Outlet 400 V		81	67	68	71	72	76	74	74	69

General fan facts, page 34-35.

RK 600 x 300 D1

RK 600 x 300 D3

With forward-curved impeller and swing-out design



RK 600 x 300 D1

PRESSURE/FLOW

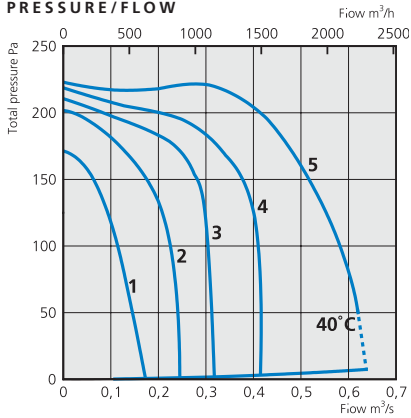

INPUT/FLOW

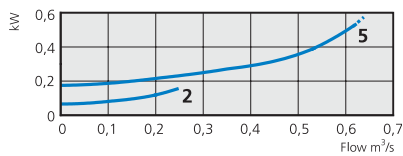

TECHNICAL DATA

Voltage, V/Hz	230/50
Current, A	2,35
Input, kW	0,53
Speed, rpm	750
Weight, kg	30
Wiring diagram	4040005
Capacitor, μ F	8
Insulation class	F
Motor protection	IP 44

DIMENSIONS (mm)

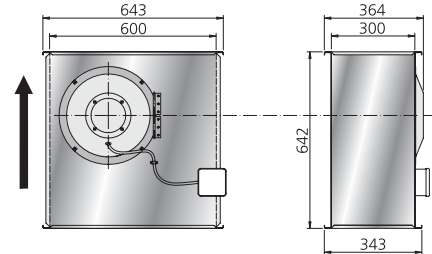

SOUND DATA

353 l/s 241 PaTot	L_{pA}	L_{wA} tot dB (A)	63	125	250	500	1K	2K	4K	8K
To environment 230 V	50	57	33	47	51	52	52	46	43	34
5. Inlet 230 V		69	61	59	64	57	61	61	61	52
4. Inlet 165 V		67	59	57	61	57	60	59	59	50
3. Inlet 135 V		64	55	53	58	54	56	55	54	44
2. Inlet 110 V		58	50	52	52	49	49	49	46	34
1. Inlet 80 V		51	40	48	44	38	39	35	28	22
Outlet 230 V		73	61	59	63	67	66	66	66	58

General fan facts, page 34-35.

RK 600 x 300 D3

PRESSURE/FLOW

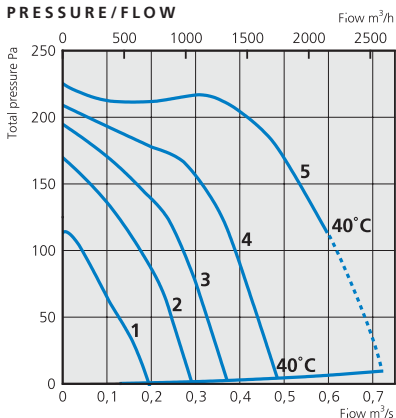

INPUT/FLOW

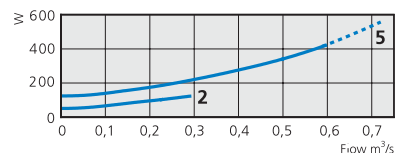

TECHNICAL DATA

Voltage, V/Hz	400/50
Current, A	0,78
Input, W	430
Speed, rpm	810
Weight, kg	30
Wiring diagram	4040005
Capacitor, μ F	-
Insulation class	F
Motor protection	IP 44

DIMENSIONS (mm)

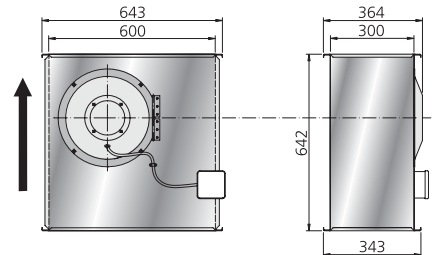

SOUND DATA

360 l/s 212 PaTot	L_{pA}	L_{wA} tot dB (A)	63	125	250	500	1K	2K	4K	8K
To environment 400 V	48	55	32	46	49	51	48	44	41	37
5. Inlet 400 V		69	61	58	63	58	61	60	60	52
4. Inlet 240 V		65	57	53	58	55	56	56	55	46
3. Inlet 185 V		61	53	50	55	51	52	52	50	39
2. Inlet 145 V		56	49	45	51	47	47	47	43	32
1. Inlet 95 V		46	39	38	42	36	38	33	27	22
Outlet 400 V		72	61	59	62	66	65	65	65	57

General fan facts, page 34-35.



RK 600 x 300 F1 RK 600 x 300 F3

With forward-curved impeller and swing-out design

RK 600 x 300 F1

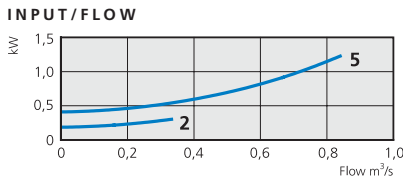
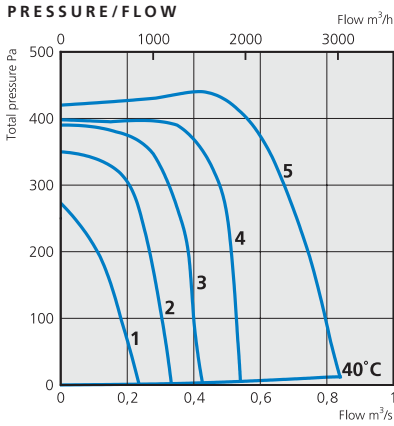

TECHNICAL DATA

Voltage, V/Hz	230/50
Current, A	5,83
Input, kW	1,23
Speed, rpm	990
Weight, kg	32
Wiring diagram	4040005
Capacitor, µF	-
Insulation class	F
Motor protection	IP 44

DIMENSIONS (mm)

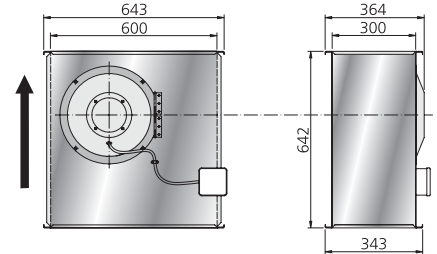

SOUND DATA

475 l/s 436 PaTot	L _{pA}	L _{wA}	tot dB (A)	63	125	250	500	1K	2K	4K	8K
To environment 230 V	57	64	41	55	57	56	59	55	54	49	
5. Inlet 230 V		79	67	70	71	65	72	72	70	65	
4. Inlet 165 V		767	65	67	69	63	69	68	66	61	
3. Inlet 135 V		72	63	64	65	60	64	64	63	56	
2. Inlet 110 V		67	58	63	58	56	57	58	56	48	
1. Inlet 80 V		61	50	59	50	49	47	49	43	32	
Outlet 230 V		82	66	69	72	73	76	75	75	69	

General fan facts, page 34-35.

RK 600 x 300 F3

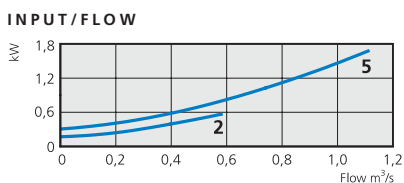
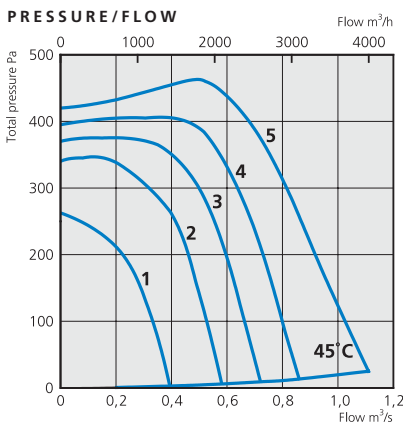

TECHNICAL DATA

Voltage, V/Hz	400/50
Current, A	3,10
Input, kW	1,68
Speed, rpm	1305
Weight, kg	32
Wiring diagram	4040004
Capacitor, µF	-
Insulation class	F
Motor protection	IP 44

DIMENSIONS (mm)

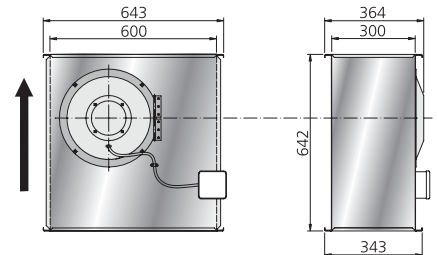

SOUND DATA

522 l/s 460 PaTot	L _{pA}	L _{wA}	tot dB (A)	63	125	250	500	1K	2K	4K	8K
To environment 400 V	58	65	41	56	58	57	60	57	55	50	
5. Inlet 400 V		80	67	70	72	67	73	74	72	67	
4. Inlet 240 V		78	66	69	70	65	71	71	69	65	
3. Inlet 185 V		76	64	67	68	64	70	69	68	63	
2. Inlet 145 V		73	63	64	65	62	66	66	65	59	
1. Inlet 95 V		66	57	57	58	57	58	59	57	48	
Outlet 400 V		85	66	69	73	75	79	78	78	73	

General fan facts, page 34-35.

RK 600 x 350 C1

RK 600 x 350 C3

With forward-curved impeller and swing-out design



RK 600 x 350 C1

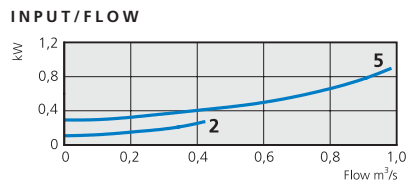
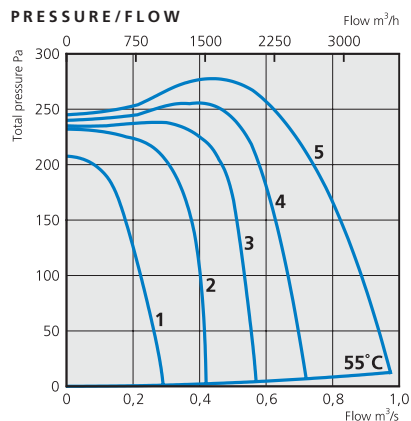

TECHNICAL DATA

Voltage, V/Hz	230/50
Current, A	4,10
Input, kW	0,89
Speed, rpm	775
Weight, kg	38
Wiring diagram	4040005
Capacitor, μ F	16
Insulation class	F
Motor protection	IP 44

DIMENSIONS (mm)

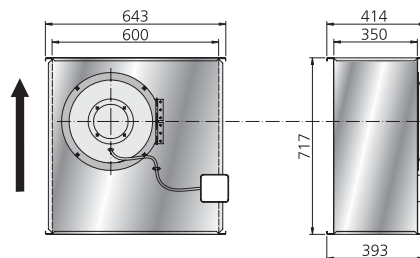

SOUND DATA

560 l/s 267 PaTot	L_{pA}	L_{wA}	tot dB (A)	63	125	250	500	1K	2K	4K	8K
To environment 230 V	56	63	37	49	61	54	54	50	48	41	
5. Inlet 230 V		71	59	65	67	59	61	62	60	52	
4. Inlet 165 V		69	59	61	60	59	61	62	60	53	
3. Inlet 135 V		67	58	59	59	58	59	60	59	50	
2. Inlet 110 V		65	55	58	56	56	56	57	55	46	
1. Inlet 80 V		61	54	56	53	53	51	52	47	37	
Outlet 230 V		77	61	64	70	70	70	69	69	61	

General fan facts, page 34-35.

RK 600 x 350 C3

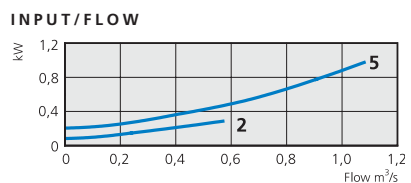
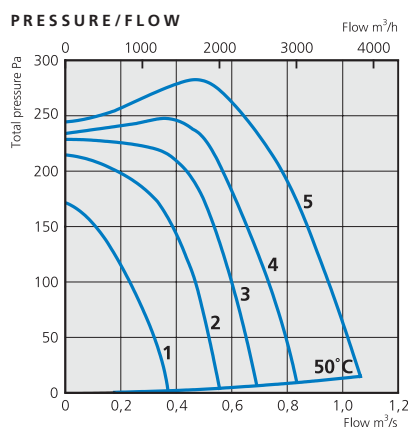

TECHNICAL DATA

Voltage, V/Hz	400/50
Current, A	2,10
Input, kW	0,98
Speed, rpm	840
Weight, kg	38
Wiring diagram	4040004
Capacitor, μ F	-
Insulation class	F
Motor protection	IP 44

DIMENSIONS (mm)

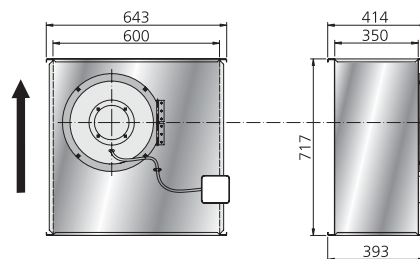

SOUND DATA

611 l/s 261 PaTot	L_{pA}	L_{wA}	tot dB (A)	63	125	250	500	1K	2K	4K	8K
To environment 400 V	53	60	35	47	53	55	54	51	48	42	
5. Inlet 400 V		70	60	64	61	59	61	62	60	53	
4. Inlet 240 V		68	59	63	60	58	60	60	59	51	
3. Inlet 185 V		67	58	61	59	56	58	59	57	48	
2. Inlet 145 V		65	55	58	56	57	56	56	54	45	
1. Inlet 95 V		59	51	53	51	50	49	49	45	34	
Outlet 400V		79	65	67	69	72	72	71	71	64	

General fan facts, page 34-35.



RK 600 x 350 E1 RK 600 x 350 E3

With forward-curved impeller and swing-out design

RK 600 x 350 E1

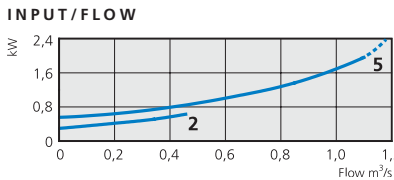
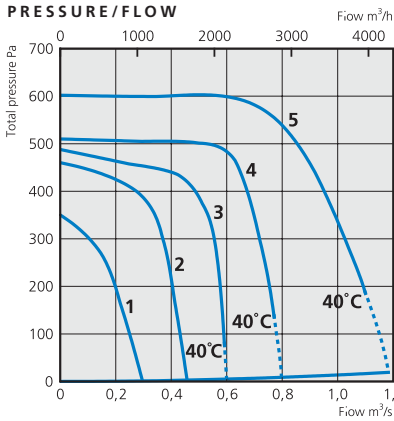

TECHNICAL DATA

Voltage, V/Hz	230/50
Current, A	9,15
Input, kW	1,96
Speed, rpm	1200
Weight, kg	42
Wiring diagram	4040005
Capacitor, µF	30
Insulation class	F
Motor protection	IP 44

DIMENSIONS (mm)

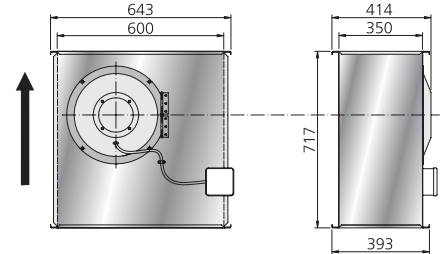

SOUND DATA

655 l/s 592 PaTot	L _{pA}	L _{wA}	tot dB (A)	63	125	250	500	1K	2K	4K	8K
To environment 230 V	60		67	44	57	62	57	62	57	56	51
5. Inlet 230 V			79	68	72	69	66	71	71	70	65
4. Inlet 165 V			78	68	71	68	66	70	71	70	65
3. Inlet 135 V			76	66	70	67	64	69	69	68	63
2. Inlet 110 V			74	64	68	64	62	65	66	65	58
1. Inlet 80 V			67	59	63	58	57	57	58	55	46
Outlet 230 V			86	69	72	74	76	80	79	78	73

General fan facts, page 34-35.

RK 600 x 350 E3

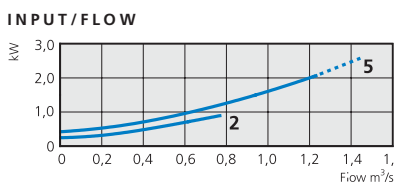
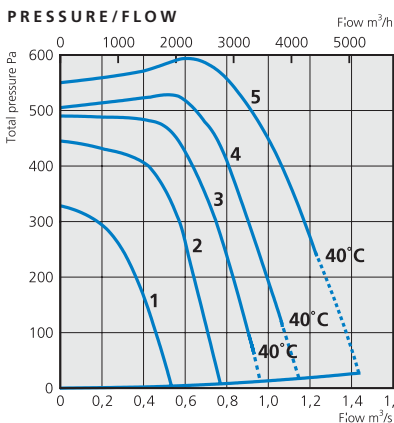

TECHNICAL DATA

Voltage, V/Hz	400/50
Current, A	3,90
Input, kW	2,06
Speed, rpm	1355
Weight, kg	42
Wiring diagram	4040004
Capacitor, µF	-
Insulation class	F
Motor protection	IP 44

DIMENSIONS (mm)

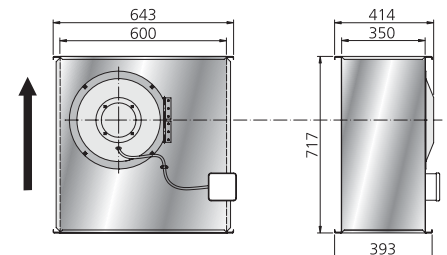

SOUND DATA

669 l/s 593 PaTot	L _{pA}	L _{wA}	tot dB (A)	63	125	250	500	1K	2K	4K	8K
To environment 400 V	61		68	42	55	60	60	63	62	58	54
5. Inlet 400 V			81	70	73	70	68	74	73	72	68
4. Inlet 240 V			79	68	71	68	67	72	72	71	66
3. Inlet 185 V			77	67	69	67	66	70	70	69	64
2. Inlet 145 V			75	64	68	65	63	67	67	66	60
1. Inlet 95 V			70	61	64	61	59	62	62	60	52
Outlet 400 V			87	69	73	74	78	82	81	80	75

General fan facts, page 34-35.

RK 700 x 400 A3

RK 700 x 400 B3

With forward-curved impeller and swing-out design



RK 700 x 400 A3

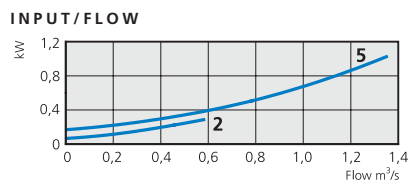
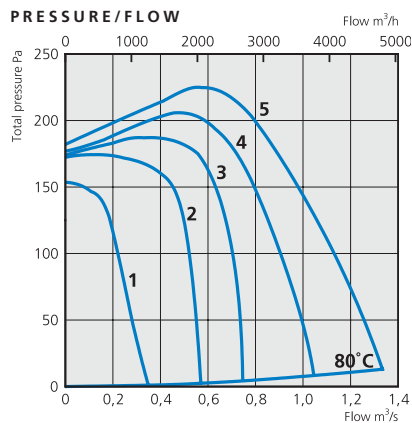

TECHNICAL DATA

Voltage, V/Hz	400/50
Current, A	2,25
Input, kW	1,02
Speed, rpm	680
Weight, kg	47
Wiring diagram	4040004
Capacitor, μ F	-
Insulation class	F
Motor protection	IP 44

DIMENSIONS (mm)

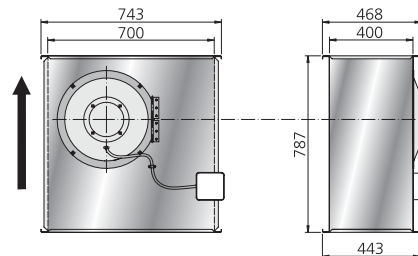

SOUND DATA

574 l/s 225 PaTot	L_{pA}	L_{wA}	tot dB (A)	63	125	250	500	1K	2K	4K	8K
To environment 400 V	48	55	39	46	50	50	48	45	40	32	
5. Inlet 400 V		67	57	58	59	57	62	60	57	48	
4. Inlet 240 V		66	56	56	58	55	61	59	56	46	
3. Inlet 185 V		66	55	56	57	56	60	58	55	46	
2. Inlet 145 V		64	53	54	56	54	59	56	53	43	
1. Inlet 95 V		55	46	45	49	45	49	46	39	33	
Outlet 400 V		77	63	64	69	69	69	69	68	61	

General fan facts, page 34-35.

RK 700 x 400 B3

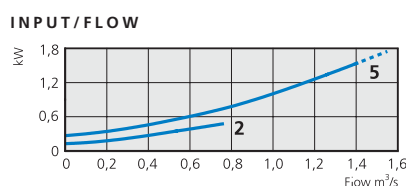
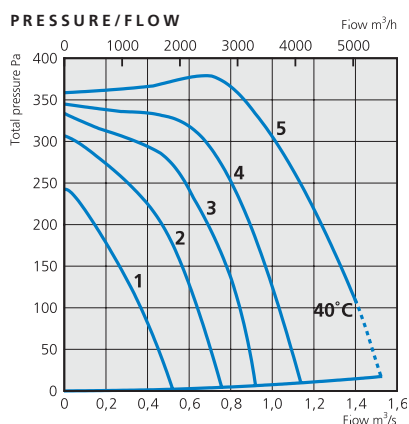

TECHNICAL DATA

Voltage, V/Hz	400/50
Current, A	3,15
Input, kW	1,54
Speed, rpm	835
Weight, kg	54
Wiring diagram	4040004
Capacitor, μ F	-
Insulation class	F
Motor protection	IP 44

DIMENSIONS (mm)

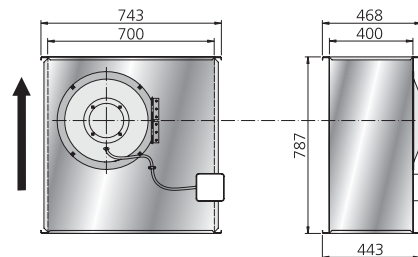

SOUND DATA

617 l/s 385 PaTot	L_{pA}	L_{wA}	tot dB (A)	63	125	250	500	1K	2K	4K	8K
To environment 400 V	61	68	41	51	56	57	62	64	61	52	
5. Inlet 400 V		75	64	65	65	63	68	68	66	60	
4. Inlet 240 V		72	62	62	62	61	65	65	64	56	
3. Inlet 185 V		69	60	60	60	58	63	62	61	53	
2. Inlet 145 V		66	57	56	57	55	60	59	58	48	
1. Inlet 95 V		59	50	50	51	50	52	52	47	37	
Outlet 400 V		79	66	66	69	70	73	72	72	65	

General fan facts, page 34-35.



RK 700 x 400 D3 RK 800 x 500 C3

With forward-curved impeller and swing-out design

RK 700 x 400 D3

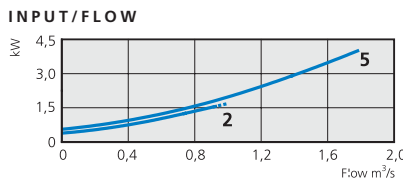
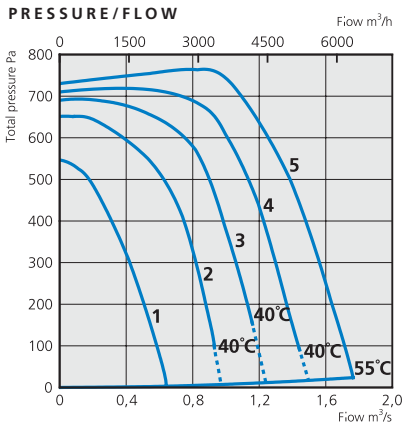

TECHNICAL DATA

Voltage, V/Hz	400/50
Current, A	6,80
Input, kW	4,00
Speed, rpm	1375
Weight, kg	60
Wiring diagram	4040004
Capacitor, μF	-
Insulation class	F
Motor protection	IP 44

DIMENSIONS (mm)

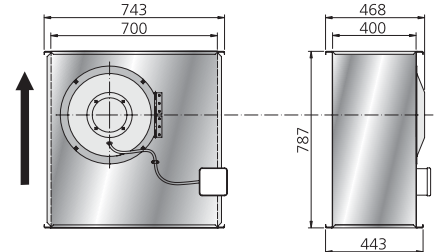

SOUND DATA

935 l/s 755 PaTot	L_{pA}	L_{wA}	tot dB (A)	63	125	250	500	1K	2K	4K	8K
To environment 400 V	67	74	57	63	66	67	68	67	65	59	
5. Inlet 400 V		87	74	76	76	72	83	81	79	75	
4. Inlet 240 V		88	74	76	77	74	84	82	80	76	
3. Inlet 185 V		84	71	73	73	71	80	78	76	72	
2. Inlet 145 V		85	69	70	70	67	76	73	72	67	
1. Inlet 95 V		73	62	63	63	61	68	66	64	57	
Outlet 400 V		90	75	76	79	78	84	84	83	78	

General fan facts, page 34-35.

RK 800 x 500 C3

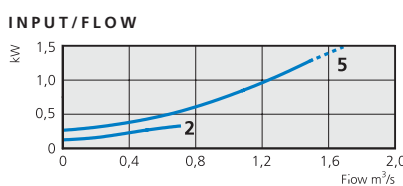
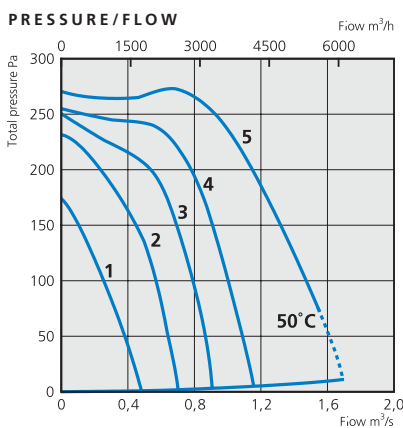

TECHNICAL DATA

Voltage, V/Hz	400/50
Current, A	2,94
Input, kW	1,29
Speed, rpm	643
Weight, kg	70
Wiring diagram	4040004
Capacitor, μF	-
Insulation class	F
Motor protection	IP 44

DIMENSIONS (mm)

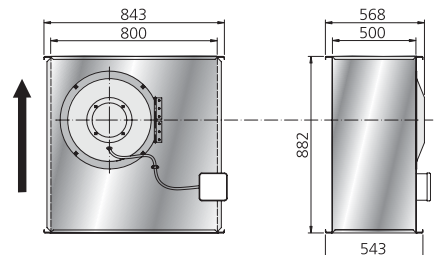

SOUND DATA

682 l/s 273 PaTot	L_{pA}	L_{wA}	tot dB (A)	63	125	250	500	1K	2K	4K	8K
To environment 400 V	51	58	39	46	50	54	53	47	42	34	
5. Inlet 400 V		71	57	62	59	62	66	65	63	54	
4. Inlet 240 V		70	55	60	58	60	64	64	61	52	
3. Inlet 185 V		67	54	57	56	57	62	61	57	48	
2. Inlet 145 V		62	49	53	54	53	57	56	51	41	
1. Inlet 95 V		53	40	45	46	43	48	46	36	25	
Outlet 400 V		77	55	62	63	70	71	70	69	60	

General fan facts, page 34-35.

RK 800 x 500 E3

RK 800 x 500 F3

With forward-curved impeller and swing-out design



RK 800 x 500 E3

PRESSURE/FLOW

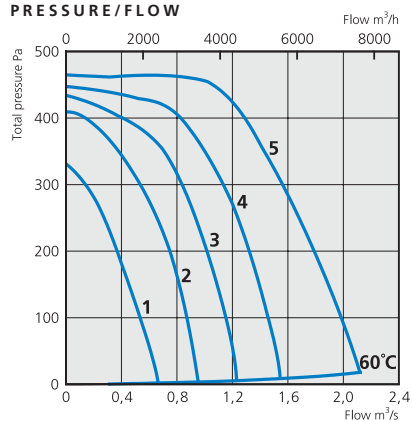

INPUT/FLOW

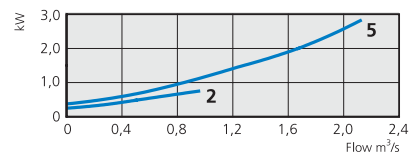

TECHNICAL DATA

Voltage, V/Hz	400/50
Current, A	5,26
Input, kW	2,81
Speed, rpm	870
Weight, kg	78
Wiring diagram	4040004
Capacitor, μ F	-
Insulation class	F
Motor protection	IP 44

DIMENSIONS (mm)

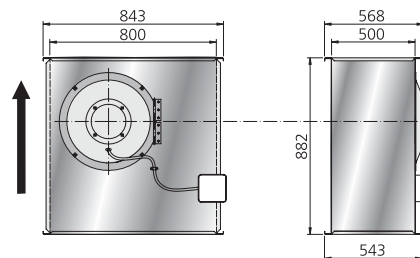

SOUND DATA

840 l/s 474 PaTot	L_{pA}	L_{wA} tot dB (A)	63	125	250	500	1K	2K	4K	8K
To environment 400 V	58	65	48	53	57	60	61	56	51	44
5. Inlet 400 V		79	64	67	65	70	75	73	71	65
4. Inlet 240 V		78	63	66	64	68	73	72	70	63
3. Inlet 185 V		76	61	64	62	66	71	70	68	60
2. Inlet 145 V		72	57	60	60	62	67	66	64	55
1. Inlet 95 V		64	50	53	56	53	58	58	52	41
Outlet 400 V		85	63	67	68	78	80	78	77	71

General fan facts, page 34-35.

RK 800 x 500 F3

PRESSURE/FLOW

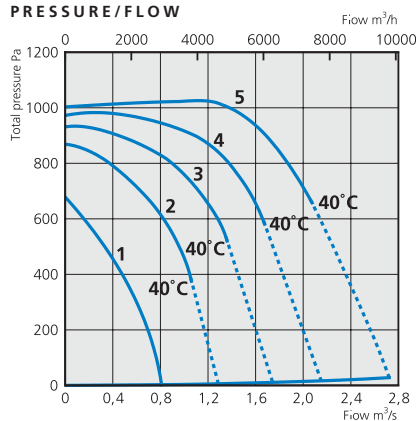

INPUT/FLOW

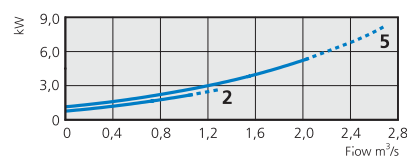

TECHNICAL DATA

Voltage, V/Hz	400/50
Current, A	9,41
Input, kW	5,35
Speed, rpm	1390
Weight, kg	81
Wiring diagram	4040004
Capacitor, μ F	-
Insulation class	F
Motor protection	IP 44

DIMENSIONS (mm)

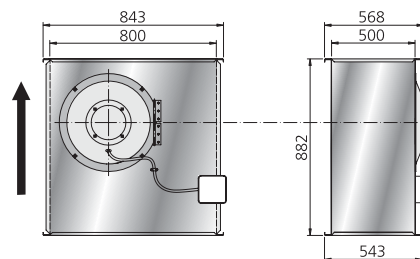

SOUND DATA

1075 l/s 1026PaTot	L_{pA}	L_{wA} tot dB (A)	63	125	250	500	1K	2K	4K	8K
To environment 400 V	68	75	60	64	64	67	72	66	60	54
5. Inlet 400 V		86	67	73	72	75	82	80	78	73
4. Inlet 240 V		86	66	72	71	75	82	80	77	72
3. Inlet 185 V		84	66	71	70	73	80	78	76	71
2. Inlet 145 V		82	64	68	67	72	78	76	74	68
1. Inlet 95 V		74	59	62	61	65	70	68	66	58
Outlet 400 V		91	65	72	73	80	88	86	83	78

General fan facts, page 34-35.



RK 1000 x 500 G3 RK 1000 x 500 H3

With forward-curved impeller and swing-out design

RK 1000 x 500 G3

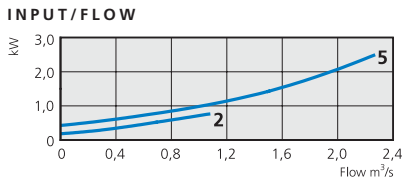
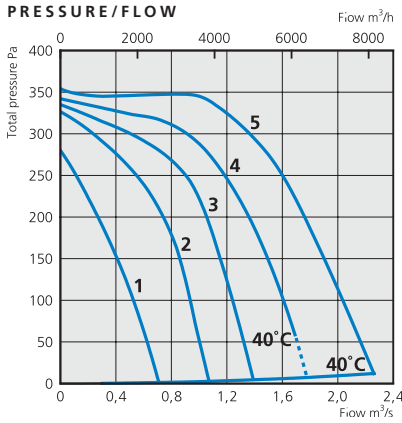

TECHNICAL DATA

Voltage, V/Hz	400/50
Current, A	5,24
Input, kW	2,48
Speed, rpm	690
Weight, kg	90
Wiring diagram	4040004
Capacitor, µF	-
Insulation class	F
Motor protection	IP 44

DIMENSIONS (mm)

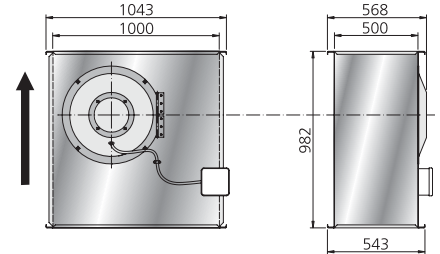

SOUND DATA

992 l/s 341 PaTot	L _{pA}	L _{wA}	tot dB (A)	63	125	250	500	1K	2K	4K	8K
To environment 400 V	59	66	47	56	56	62	58	57	54	47	
5. Inlet 400 V		76	61	63	62	70	70	70	68	59	
4. Inlet 240 V		79	63	65	64	72	73	72	71	64	
3. Inlet 185 V		76	62	63	62	70	70	70	69	60	
2. Inlet 145 V		73	60	59	61	66	66	67	65	55	
1. Inlet 95 V		65	52	55	55	59	59	59	56	43	
Outlet 400 V		82	61	65	67	76	78	76	74	65	

General fan facts, page 34-35.

RK 1000 x 500 H3

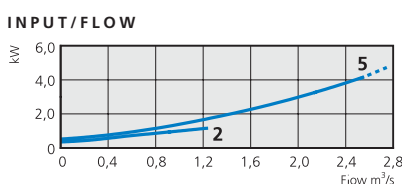
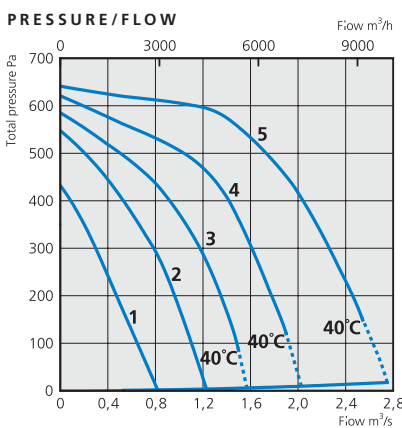

TECHNICAL DATA

Voltage, V/Hz	400/50
Current, A	7,4
Input, kW	4,15
Speed, rpm	890
Weight, kg	90
Wiring diagram	4040004
Capacitor, µF	-
Insulation class	F
Motor protection	IP 44

DIMENSIONS (mm)

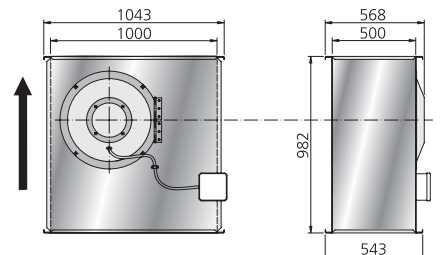

SOUND DATA

1180 l/s 594 PaTot	L _{pA}	L _{wA}	tot dB (A)	63	125	250	500	1K	2K	4K	8K
To environment 400 V	63	70	54	62	61	65	63	61	56	50	
5. Inlet 400 V		80	64	67	65	74	75	74	73	66	
4. Inlet 240 V		75	60	61	61	68	68	68	67	57	
3. Inlet 185 V		72	58	60	59	66	66	66	65	54	
2. Inlet 145 V		69	55	56	58	63	63	63	61	49	
1. Inlet 95 V		62	47	49	58	54	54	54	48	35	
Outlet 400 V		86	64	69	69	78	82	80	78	71	

General fan facts, page 34-35.

RKB 300 x 150 C1

RKB 400 x 200 A1

With backward-curved impeller and swing-out design



RKB 300 x 150 C1

PRESSURE/FLOW

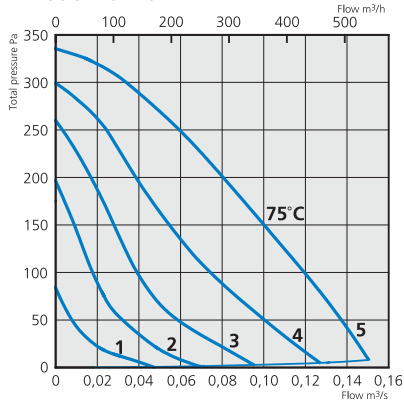

INPUT/FLOW

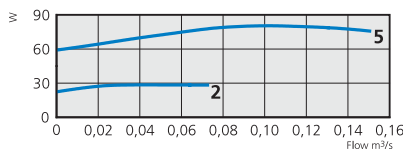

TECHNICAL DATA

Voltage, V/Hz	230/50
Current, A	0,35
Input, W	65
Speed, rpm	2465
Weight, kg	6
Wiring diagram	4040001
Capacitor, μ F	2
Insulation class	F
Motor protection	IP 44

DIMENSIONS (mm)

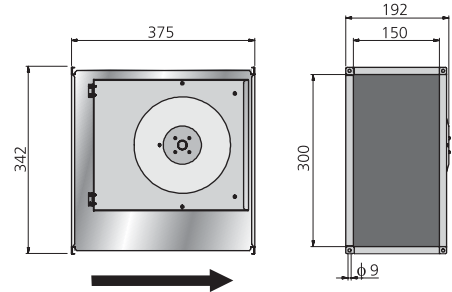

SOUND DATA

75 l/s 230 Pa	L_{pA}	L_{wA}	tot dB (A)	63	125	250	500	1K	2K	4K	8K
To environment 230 V	50	57	31	36	52	56	47	44	38	34	
5. Inlet 230 V		71	49	56	65	69	59	55	50	45	
4. Inlet 165 V		67	47	55	62	65	53	47	46	40	
3. Inlet 135 V		61	41	50	57	59	47	39	38	29	
2. Inlet 110 V		52	35	45	49	49	36	28	24	13	
1. Inlet 80 V		42	28	38	39	37	23	14	9	7	
Outlet 230 V		72	53	55	65	68	66	61	56	47	

General fan facts, page 34-35.

RKB 400 x 200 A1

PRESSURE/FLOW

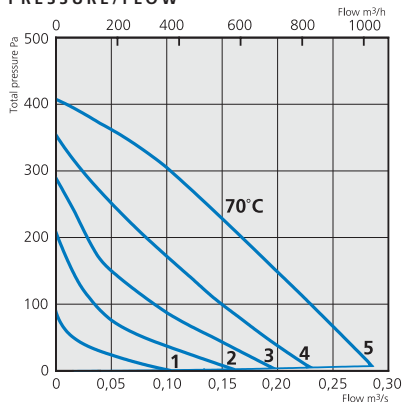

INPUT/FLOW

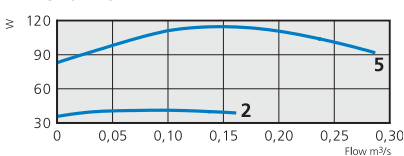

TECHNICAL DATA

Voltage, V/Hz	230/50
Current, A	0,46
Input, W	113
Speed, rpm	2530
Weight, kg	9
Wiring diagram	4040001
Capacitor, μ F	3
Insulation class	F
Motor protection	IP 44

DIMENSIONS (mm)

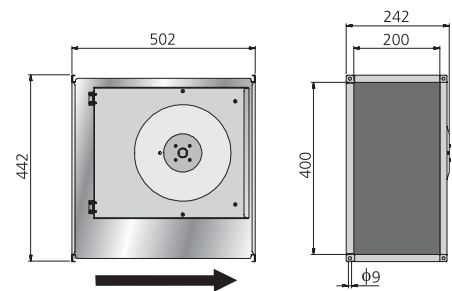

SOUND DATA

130 l/s 230 Pa	L_{pA}	L_{wA}	tot dB (A)	63	125	250	500	1K	2K	4K	8K
To environment 230 V	53	60	28	42	54	58	53	52	46	32	
5. Inlet 230 V		72	50	60	68	68	65	60	60	49	
4. Inlet 165 V		69	50	59	65	64	59	56	54	42	
3. Inlet 135 V		63	46	55	59	57	53	50	46	33	
2. Inlet 110 V		57	42	52	53	50	45	39	34	21	
1. Inlet 80 V		47	37	43	43	41	33	25	18	13	
Outlet 230 V		75	53	61	70	71	66	69	65	53	

General fan facts, page 34-35.



RKB 400 x 200 B1 RKB 400 x 200 E1

With backward-curved impeller and swing-out design

RKB 400 x 200 B1

PRESSURE/FLOW

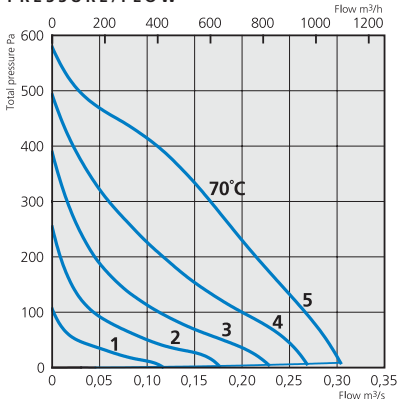

INPUT/FLOW

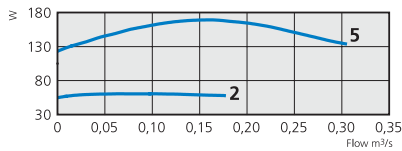

TECHNICAL DATA

Voltage, V/Hz	230/50
Current, A	0,72
Input, W	164
Speed, rpm	2500
Weight, kg	10
Wiring diagram	4040001
Capacitor, μ F	4
Insulation class	F
Motor protection	IP 44

DIMENSIONS (mm)

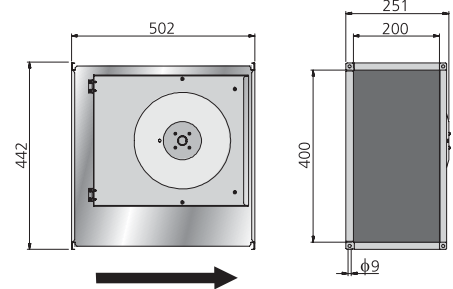

SOUND DATA

160 l/s 365 Pa	L_{pA}	L_{WA}	tot dB (A)	63	125	250	500	1K	2K	4K	8K
To environment 230 V	57	64	33	41	57	61	56	56	48	41	
5. Inlet 230 V		75	58	62	70	69	66	67	67	61	
4. Inlet 165 V		69	53	57	65	62	59	60	60	53	
3. Inlet 135 V		64	48	54	61	56	52	54	52	44	
2. Inlet 110 V		59	43	54	54	50	46	47	44	35	
1. Inlet 80 V		55	38	54	45	41	36	37	32	20	
Outlet 230 V		80	59	66	71	75	71	73	70	66	

General fan facts, page 34-35.

RKB 400 x 200 E1

PRESSURE/FLOW

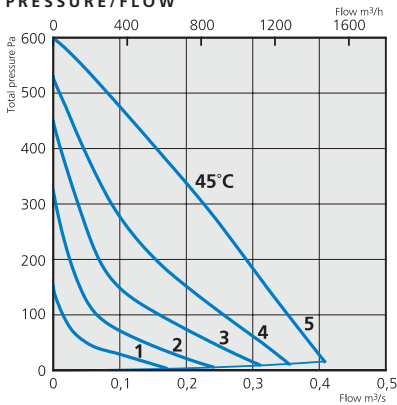

INPUT/FLOW

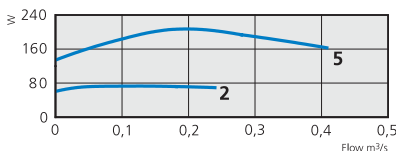

TECHNICAL DATA

Voltage, V/Hz	230/50
Current, A	0,91
Input, W	207
Speed, rpm	2400
Weight, kg	11
Wiring diagram	4040001
Capacitor, μ F	5
Insulation class	F
Motor protection	IP 44

DIMENSIONS (mm)

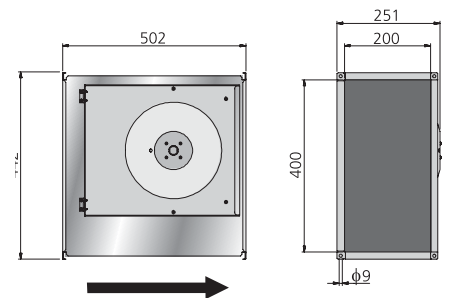

SOUND DATA

160 l/s 365 Pa	L_{pA}	L_{WA}	tot dB (A)	63	125	250	500	1K	2K	4K	8K
To environment 230 V	56	63	35	48	54	61	56	52	47	40	
5. Inlet 230 V		75	56	66	69	71	67	65	66	62	
4. Inlet 165 V		69	53	61	64	65	60	57	57	51	
3. Inlet 135 V		64	48	56	62	58	54	51	50	42	
2. Inlet 110 V		59	43	52	57	52	48	44	42	33	
1. Inlet 80 V		51	36	49	46	42	38	32	28	22	
Outlet 230 V		78	59	65	69	74	70	69	67	62	

General fan facts, page 34-35.

RKB 500 x 250 A1

RKB 500 x 250 C1

With backward-curved impeller and swing-out design



RKB 500 x 250 A1

PRESSURE/FLOW

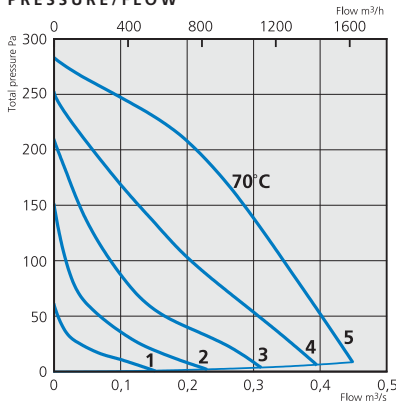

INPUT/FLOW

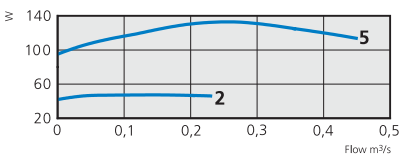

TECHNICAL DATA

Voltage, V/Hz	230/50
Current, A	0,59
Input, W	133
Speed, rpm	1270
Weight, kg	10
Wiring diagram	4040001
Capacitor, μ F	5
Insulation class	F
Motor protection	IP 44

DIMENSIONS (mm)

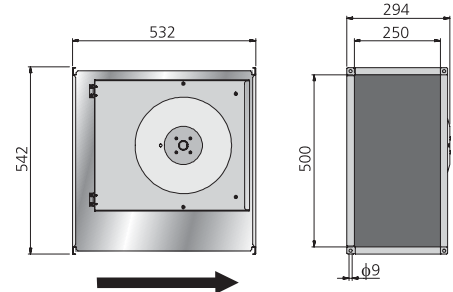

SOUND DATA

195 l/s 205 Pa	L_{pA}	L_{wA}	tot dB (A)	63	125	250	500	1K	2K	4K	8K
To environment 230 V	48	55	35	51	48	47	49	44	36	29	
5. Inlet 230 V		67	56	62	63	58	53	55	50	41	
4. Inlet 165 V		66	62	61	59	56	49	50	44	33	
3. Inlet 135 V		58	53	55	53	47	41	41	34	22	
2. Inlet 110 V		54	48	52	46	40	33	32	23	17	
1. Inlet 80 V		51	34	51	38	31	27	22	17	13	
Outlet 230 V		70	58	63	63	62	61	63	57	48	

General fan facts, page 34-35.

RKB 500 x 250 C1

PRESSURE/FLOW

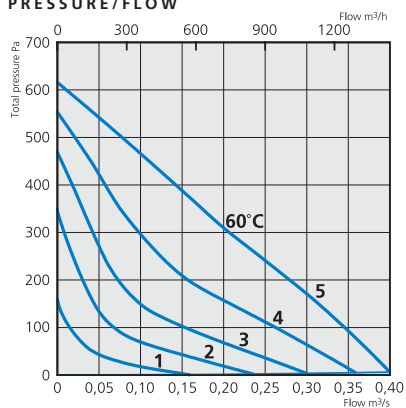

INPUT/FLOW

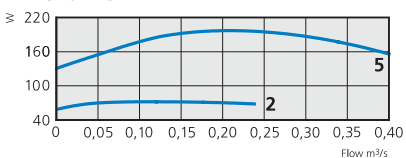

TECHNICAL DATA

Voltage, V/Hz	230/50
Current, A	0,86
Input, W	196
Speed, rpm	2460
Weight, kg	15
Wiring diagram	4040001
Capacitor, μ F	5
Insulation class	F
Motor protection	IP 44

DIMENSIONS (mm)

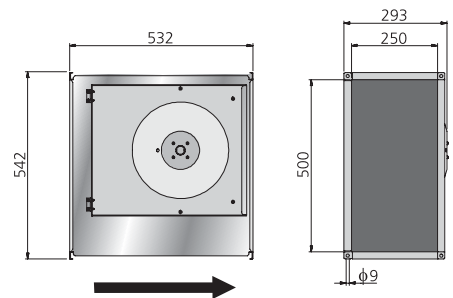

SOUND DATA

205 l/s 295 Pa	L_{pA}	L_{wA}	tot dB (A)	63	125	250	500	1K	2K	4K	8K
To environment 230 V	52	59	34	44	51	56	52	51	47	39	
5. Inlet 230 V		71	57	61	65	63	63	65	62	58	
4. Inlet 165 V		68	53	58	62	62	59	60	57	54	
3. Inlet 135 V		65	49	60	62	53	53	54	53	44	
2. Inlet 110 V		58	44	52	56	44	46	46	44	31	
1. Inlet 80 V		48	40	46	42	35	36	32	25	21	
Outlet 230 V		77	57	59	65	74	68	71	66	61	

General fan facts, page 34-35.



RKB 500 x 250 E1 RKB 600 x 300 A1

With backward-curved impeller and swing-out design

RKB 500 x 250 E1

PRESSURE/FLOW

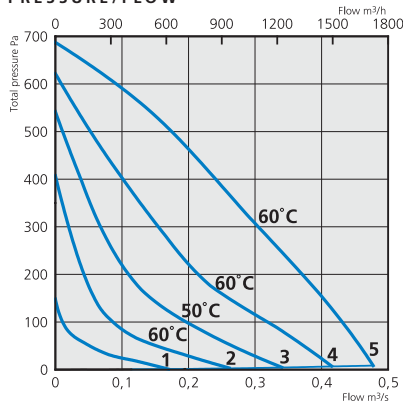

INPUT/FLOW

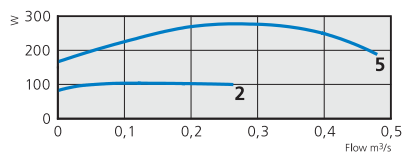

TECHNICAL DATA

Voltage, V/Hz	230/50
Current, A	1,21
Input, W	277
Speed, rpm	2455
Weight, kg	15
Wiring diagram	4040001
Capacitor, µF	8
Insulation class	F
Motor protection	IP 44

DIMENSIONS (mm)

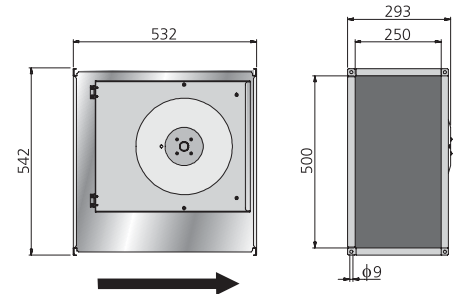

SOUND DATA

255 l/s 370 Pa	L _{pA}	L _{wA}	tot dB (A)	63	125	250	500	1K	2K	4K	8K
To environment 230 V	58	65	41	54	60	62	57	54	49	41	
5. Inlet 230 V		77	58	71	75	67	67	67	66	61	
4. Inlet 165 V		70	55	66	66	59	58	58	56	50	
3. Inlet 135 V		67	57	65	60	52	51	52	49	42	
2. Inlet 110 V		64	55	63	54	46	44	45	41	33	
1. Inlet 80 V*		59	48	59	46	38	36	35	30	25	
Outlet 230 V		81	57	70	75	77	72	73	70	65	

General fan facts, page 34-35.

RKB 600 x 300 A1

PRESSURE/FLOW

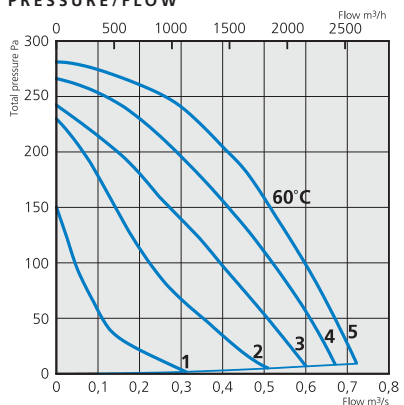

INPUT/FLOW

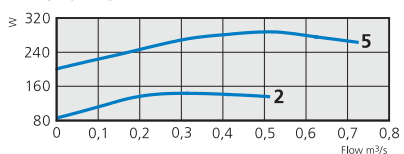

TECHNICAL DATA

Voltage, V/Hz	230/50
Current, A	1,30
Input, W	287
Speed, rpm	925
Weight, kg	31
Wiring diagram	4040001
Capacitor, µF	8
Insulation class	F
Motor protection	IP 44

DIMENSIONS (mm)

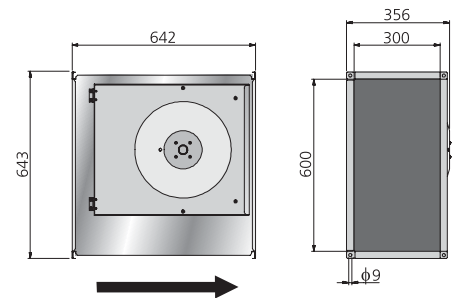

SOUND DATA

455 l/s 190 Pa	L _{pA}	L _{wA}	tot dB (A)	63	125	250	500	1K	2K	4K	8K
To environment 230 V	50	57	38	50	51	50	52	43	35	29	
5. Inlet 230 V		68	58	63	63	60	58	57	52	43	
4. Inlet 165 V		66	57	61	61	58	56	54	49	40	
3. Inlet 135 V		64	56	59	58	56	54	51	46	37	
2. Inlet 110 V		58	52	51	52	50	48	44	39	29	
1. Inlet 80 V		51	46	45	44	42	39	35	29	24	
Outlet 230 V		73	62	64	67	66	67	63	57	48	

General fan facts, page 34-35.

RKB 600 x 300 B1

RKB 600 x 300 G1

With backward-curved impeller and swing-out design



RKB 600 x 300 B1

PRESSURE/FLOW

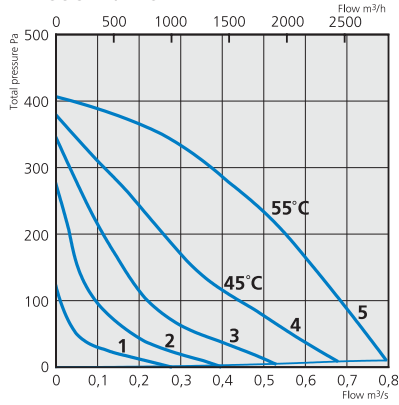

INPUT/FLOW

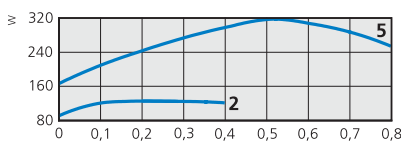

TECHNICAL DATA

Voltage, V/Hz	230/50
Current, A	1,46
Input, W	318
Speed, rpm	1305
Weight, kg	23
Wiring diagram	4040001
Capacitor, µF	6
Insulation class	F
Motor protection	IP 44

DIMENSIONS (mm)

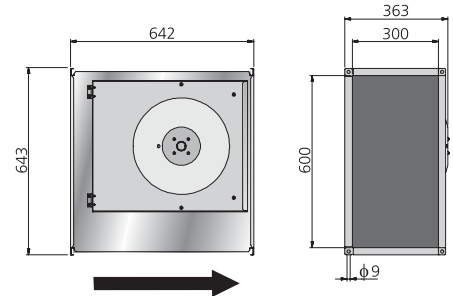

SOUND DATA

300 l/s 335 Pa	L _{pA}	L _{wA}	tot dB (A)	63	125	250	500	1K	2K	4K	8K
To environment 230 V	52		59	45	53	54	53	53	51	46	37
5. Inlet 230 V			72	61	67	69	58	61	60	56	48
4. Inlet 165 V			67	54	62	65	55	55	55	51	40
3. Inlet 135 V			59	49	56	55	46	47	46	39	28
2. Inlet 110 V			52	46	48	47	39	40	37	28	20
1. Inlet 80 V			44	41	40	38	29	28	23	20	16
Outlet 230 V			76	59	65	73	67	69	67	60	52

General fan facts, page 34-35.

RKB 600 x 300 G1

PRESSURE/FLOW

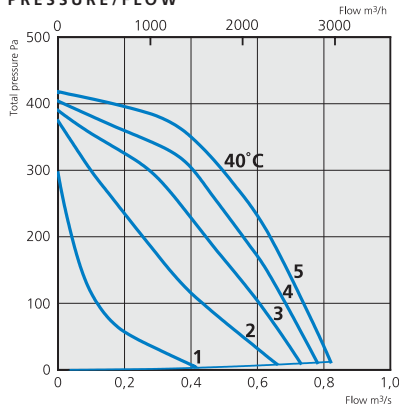

INPUT/FLOW

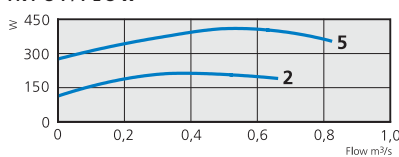

TECHNICAL DATA

Voltage, V/Hz	230/50
Current, A	2,10
Input, W	409
Speed, rpm	1410
Weight, kg	26
Wiring diagram	4040001
Capacitor, µF	12
Insulation class	F
Motor protection	IP 44

DIMENSIONS (mm)

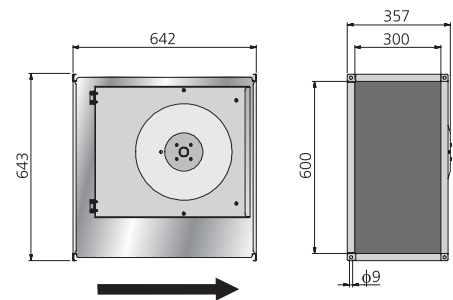

SOUND DATA

425 l/s 320 Pa	L _{pA}	L _{wA}	tot dB (A)	63	125	250	500	1K	2K	4K	8K
To environment 230 V	57		64	40	56	59	59	58	52	42	35
5. Inlet 230 V			77	55	72	75	62	62	64	59	52
4. Inlet 165 V			74	54	64	72	62	62	63	57	50
3. Inlet 135 V			71	55	64	69	60	60	61	55	48
2. Inlet 110 V			66	55	61	63	54	54	55	50	39
1. Inlet 80 V			60	54	55	55	48	49	49	42	33
Outlet 230 V			81	58	76	77	70	70	71	63	56

General fan facts, page 34-35.



RKB 600 x 350 A1

RKB 600 x 350 B1

With backward-curved impeller and swing-out design

RKB 600 x 350 A1

PRESSURE/FLOW

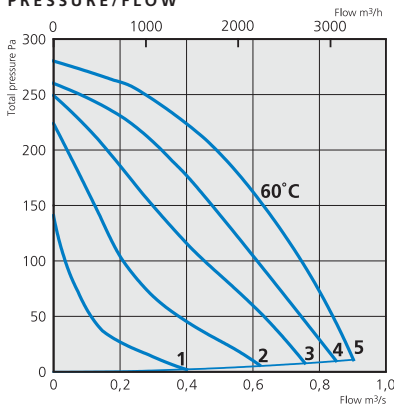

INPUT/FLOW

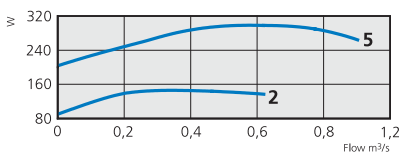

TECHNICAL DATA

Voltage, V/Hz	230/50
Current, A	1,34
Input, W	298
Speed, rpm	920
Weight, kg	31
Wiring diagram	4040001
Capacitor, μ F	8
Insulation class	F
Motor protection	IP 44

DIMENSIONS (mm)

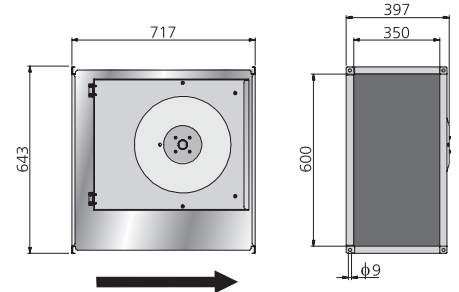

SOUND DATA

450 l/s 208 Pa	L_{pA}	L_{WA}	tot dB (A)	63	125	250	500	1K	2K	4K	8K
To environment 230 V	49	56	38	47	47	51	52	44	35	29	
5. Inlet 230 V		68	57	62	64	58	59	58	52	45	
4. Inlet 165 V		66	56	60	62	56	56	55	50	42	
3. Inlet 135 V		63	55	56	59	53	53	51	46	38	
2. Inlet 110 V		57	52	50	53	46	46	43	38	29	
1. Inlet 80 V		51	46	45	46	39	38	35	30	24	
Outlet 230 V		71	57	64	66	64	66	62	56	49	

General fan facts, page 34-35.

RKB 600 x 350 B1

PRESSURE/FLOW

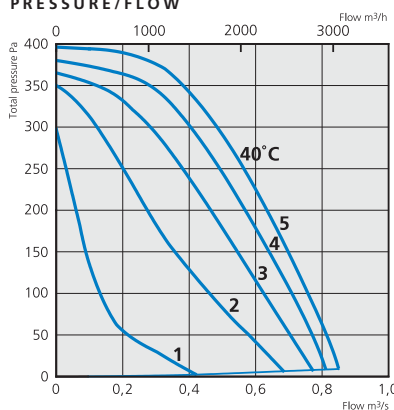

INPUT/FLOW

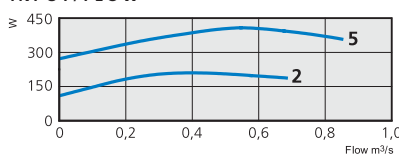

TECHNICAL DATA

Voltage, V/Hz	230/50
Current, A	2,11
Input, W	412
Speed, rpm	1405
Weight, kg	30
Wiring diagram	4040001
Capacitor, μ F	12
Insulation class	F
Motor protection	IP 44

DIMENSIONS (mm)

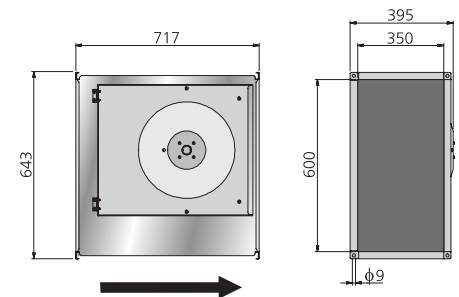

SOUND DATA

375 l/s 355 Pa	L_{pA}	L_{WA}	tot dB (A)	63	125	250	500	1K	2K	4K	8K
To environment 230 V	57	64	38	63	57	53	54	50	45	34	
5. Inlet 230 V		79	58	76	75	60	62	67	65	55	
4. Inlet 165 V		77	57	68	75	61	64	68	67	56	
3. Inlet 135 V		73	56	66	69	58	61	66	63	52	
2. Inlet 110 V		67	52	63	60	52	57	61	54	43	
1. Inlet 80 V		61	53	59	52	45	49	50	40	32	
Outlet 230 V		79	58	69	75	67	70	71	69	58	

General fan facts, page 34-35.

RKB 600 x 350 B3

RKB 600 x 350 D1

With backward-curved impeller and swing-out design



RKB 600 x 350 B3

PRESSURE/FLOW

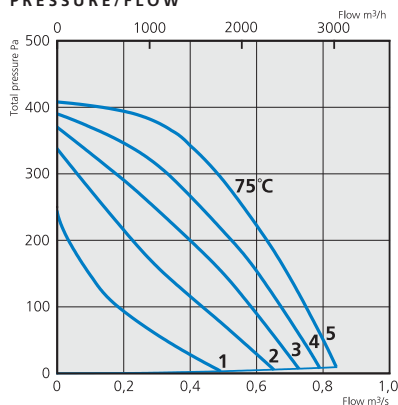

INPUT/FLOW

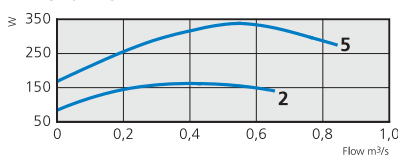

TECHNICAL DATA

Voltage, V/Hz	400/50
Current, A	1,04
Input, W	388
Speed, rpm	1415
Weight, kg	32
Wiring diagram	4040004
Capacitor, µF	-
Insulation class	F
Motor protection	IP 44

DIMENSIONS (mm)

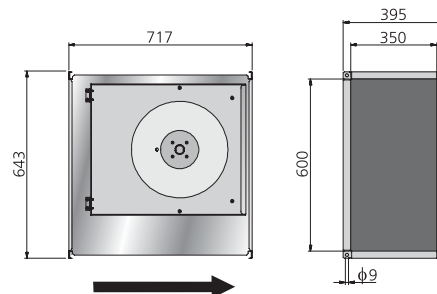

SOUND DATA

375 l/s 350 Pa	L _{pA}	L _{wA}	tot dB (A)	63	125	250	500	1K	2K	4K	8K
To environment 400 V	53	60	37	51	56	52	53	50	46	34	
5. Inlet 400 V		76	59	66	74	59	62	66	65	55	
4. Inlet 240 V		75	57	68	71	60	63	66	66	55	
3. Inlet 185 V		72	54	67	67	57	60	65	62	50	
2. Inlet 145 V		67	52	61	62	53	57	62	56	43	
1. Inlet 95 V		58	48	54	52	44	49	52	39	30	
Outlet 400 V		78	58	66	75	67	69	70	69	58	

General fan facts, page 34-35.

RKB 600 x 350 D1

PRESSURE/FLOW

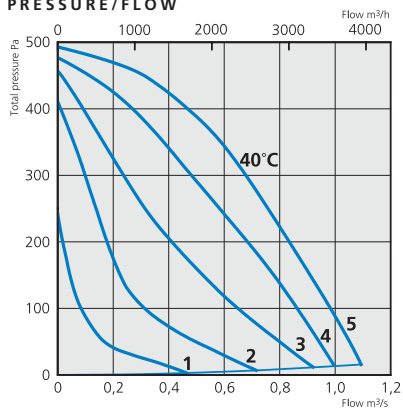

INPUT/FLOW

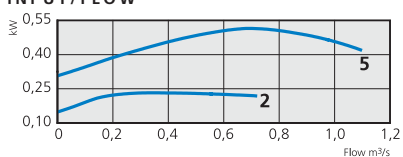

TECHNICAL DATA

Voltage, V/Hz	230/50
Current, A	2,46
Input, kW	0,52
Speed, rpm	1370
Weight, kg	31
Wiring diagram	4040001
Capacitor, µF	12
Insulation class	F
Motor protection	IP 44

DIMENSIONS (mm)

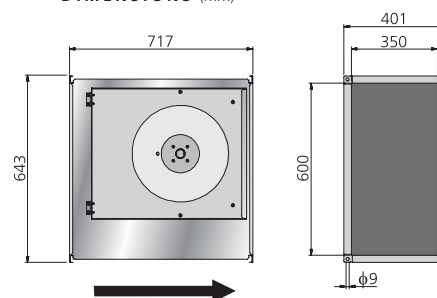

SOUND DATA

580 l/s 355 Pa	L _{pA}	L _{wA}	tot dB (A)	63	125	250	500	1K	2K	4K	8K
To environment 230 V	55	62	38	52	58	56	56	54	49	41	
5. Inlet 230 V		78	62	69	77	65	66	68	62	56	
4. Inlet 165 V		75	61	69	72	62	63	65	59	53	
3. Inlet 135 V		68	56	63	64	57	57	58	53	45	
2. Inlet 110 V		62	53	60	57	50	50	49	48	32	
1. Inlet 80 V		56	49	54	47	40	38	40	28	19	
Outlet 230 V		82	63	70	80	72	75	73	67	61	

General fan facts, page 34-35.



RKB 600 x 350 D3 RKB 700 x 400 C1

With backward-curved impeller and swing-out design

RKB 600 x 350 D3

PRESSURE/FLOW

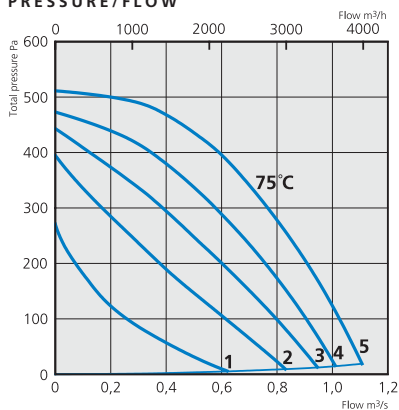

INPUT/FLOW

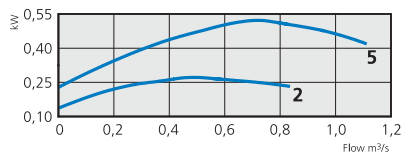

TECHNICAL DATA

Voltage, V/Hz	400/50
Current, A	1,27
Input, kW	0,52
Speed, rpm	1415
Weight, kg	24
Wiring diagram	4040030
Capacitor, µF	-
Insulation class	F
Motor protection	IP 44

DIMENSIONS (mm)

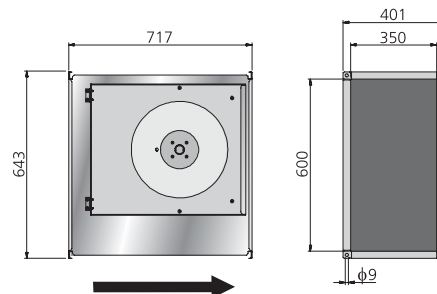

SOUND DATA

535 l/s 425 Pa	L _{pA}	L _{wA}	tot dB (A)	63	125	250	500	1K	2K	4K	8K
To environment 400 V	55	62	41	51	60	54	55	50	43	35	
5. Inlet 400 V		76	62	68	75	64	63	65	61	55	
4. Inlet 240 V		74	60	67	72	62	61	62	58	53	
3. Inlet 185 V		70	59	66	67	59	58	59	55	50	
2. Inlet 145 V		66	57	63	62	56	55	55	52	45	
1. Inlet 95 V		59	52	55	55	48	46	46	43	35	
Outlet 400 V		81	62	69	80	72	72	71	65	60	

General fan facts, page 34-35.

RKB 700 x 400 C1

PRESSURE/FLOW

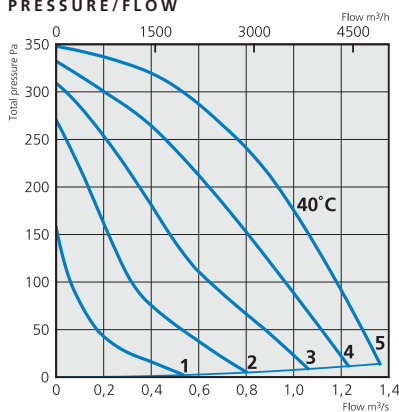

INPUT/FLOW

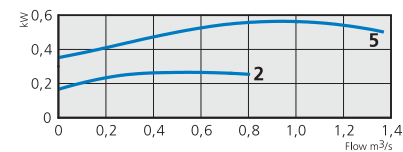

TECHNICAL DATA

Voltage, V/Hz	230/50
Current, A	2,73
Input, kW	0,56
Speed, rpm	910
Weight, kg	41
Wiring diagram	4040001
Capacitor, µF	12
Insulation class	F
Motor protection	IP 44

DIMENSIONS (mm)

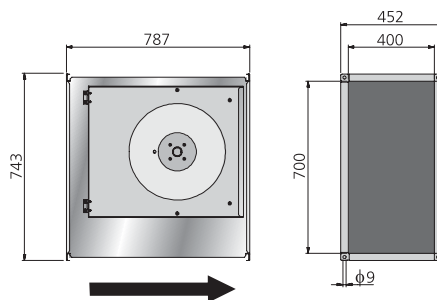

SOUND DATA

560 l/s 290 Pa	L _{pA}	L _{wA}	tot dB (A)	63	125	250	500	1K	2K	4K	8K
To environment 230 V	55	62	42	55	56	57	57	54	47	35	
5. Inlet 230 V		72	62	65	66	63	67	61	56	49	
4. Inlet 165 V		69	60	63	63	60	64	58	53	45	
3. Inlet 135 V		66	57	61	60	56	59	53	47	38	
2. Inlet 110 V		60	53	57	53	50	51	45	37	30	
1. Inlet 80 V		51	43	50	43	38	38	29	29	26	
Outlet 230 V		75	62	67	69	69	70	66	59	52	

General fan facts, page 34-35.

RKB 700 x 400 C3

RKB 700 x 400 E1

With backward-curved impeller and swing-out design



RKB 700 x 400 C3

PRESSURE/FLOW

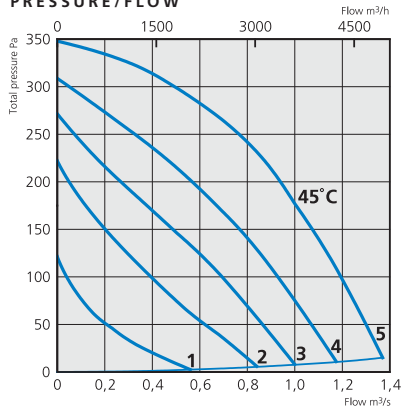

INPUT/FLOW

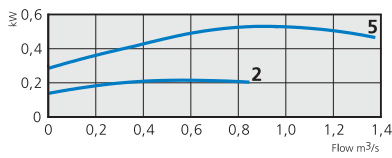

TECHNICAL DATA

Voltage, V/Hz	400/50
Current, A	1,20
Input, kW	0,53
Speed, rpm	920
Weight, kg	42
Wiring diagram	4040030
Capacitor, µF	-
Insulation class	F
Motor protection	IP 44

DIMENSIONS (mm)

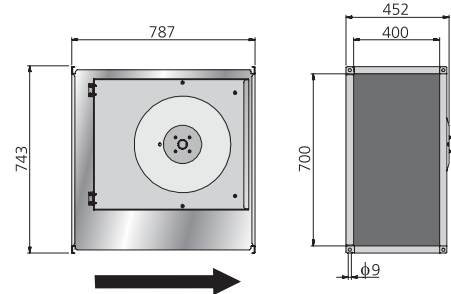

SOUND DATA

490 l/s 315 Pa	L _{pA}	L _{wA}	tot dB (A)	63	125	250	500	1K	2K	4K	8K
To environment 400 V	57	64	63	43	52	57	57	60	57	51	35
5. Inlet 400 V		72	63	64	66	63	66	61	57	50	
4. Inlet 240 V		69	59	63	64	61	64	59	54	45	
3. Inlet 185 V		66	57	61	61	57	59	54	49	40	
2. Inlet 145 V		61	55	53	56	52	53	48	42	34	
1. Inlet 95 V		50	46	42	45	41	41	33	27	30	
Outlet 400 V		75	62	65	69	69	69	67	61	53	

General fan facts, page 34-35.

RKB 700 x 400 E1

PRESSURE/FLOW

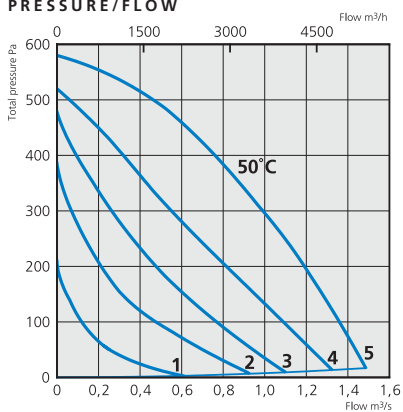

INPUT/FLOW

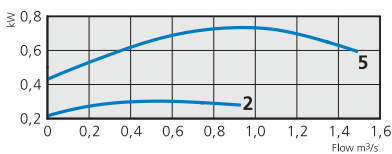

TECHNICAL DATA

Voltage, V/Hz	230/50
Current, A	3,30
Input, W	731
Speed, rpm	1252
Weight, kg	39
Wiring diagram	4040001
Capacitor, µF	16
Insulation class	F
Motor protection	IP 44

DIMENSIONS (mm)

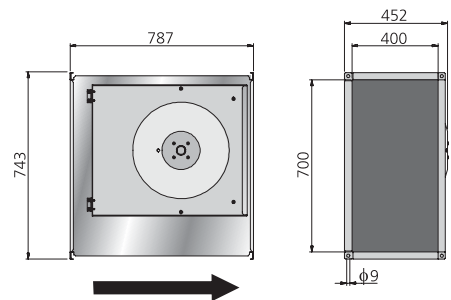

SOUND DATA

570 l/s 465 Pa	L _{pA}	L _{wA}	tot dB (A)	63	125	250	500	1K	2K	4K	8K
To environment 230 V	56	63	44	54	60	56	56	50	42	35	
5. Inlet 230 V		75	61	68	70	65	68	67	62	56	
4. Inlet 165 V		71	58	66	66	62	64	62	56	50	
3. Inlet 135 V		67	55	62	61	57	60	57	52	44	
2. Inlet 110 V		61	51	57	55	50	52	49	44	35	
1. Inlet 80 V		53	47	50	46	42	42	38	32	20	
Outlet 230 V		79	60	71	74	70	74	70	64	57	

General fan facts, page 34-35.



RKB 700 x 400 E3 RKB 800 x 500 B1

With backward-curved impeller and swing-out design

RKB 700 x 400 E3

PRESSURE/FLOW

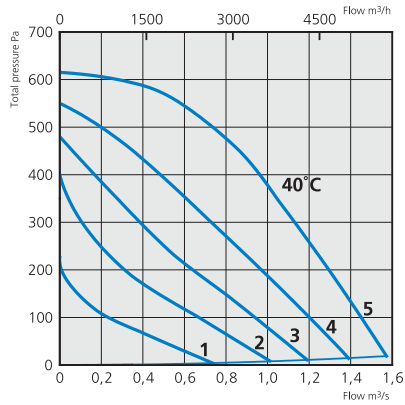

INPUT/FLOW

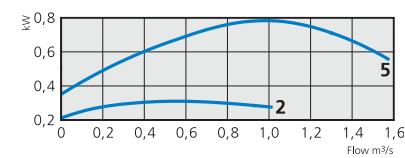

TECHNICAL DATA

Voltage, V/Hz	400/50
Current, A	1,55
Input, kW	0,78
Speed, rpm	1358
Weight, kg	39
Wiring diagram	4040030
Capacitor, µF	-
Insulation class	F
Motor protection	IP 44

DIMENSIONS (mm)

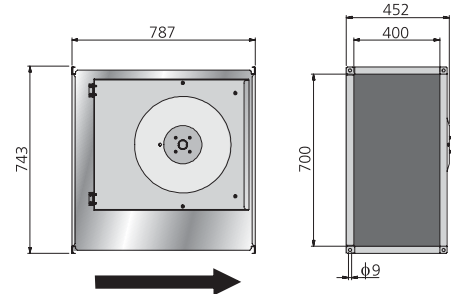

SOUND DATA

630 l/s 515 Pa	L _{pA}	L _{wA} tot dB (A)	63	125	250	500	1K	2K	4K	8K
To environment 400 V	59	66	43	55	63	59	59	53	46	38
5. Inlet 400 V		77	62	69	73	67	71	69	64	58
4. Inlet 240 V		74	60	69	69	65	67	64	58	52
3. Inlet 185 V		69	56	65	63	60	62	59	54	46
2. Inlet 145 V		63	53	58	57	53	56	53	47	39
1. Inlet 95 V		53	48	45	47	45	44	40	34	26
Outlet 400 V	83	63	72	81	73	77	73	73	66	60

General fan facts, page 34-35.

RKB 800 x 500 B1

PRESSURE/FLOW

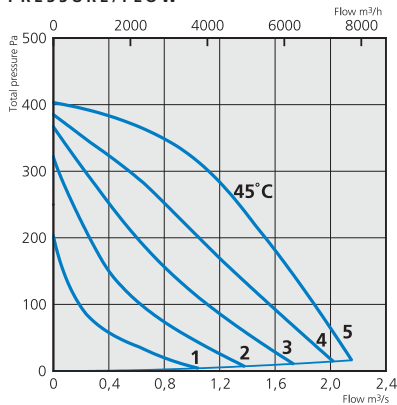

INPUT/FLOW

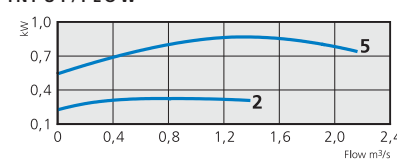

TECHNICAL DATA

Voltage, V/Hz	230/50
Current, A	4,44
Input, kW	0,87
Speed, rpm	871
Weight, kg	64
Wiring diagram	4040001
Capacitor, µF	25
Insulation class	F
Motor protection	IP 44

DIMENSIONS (mm)

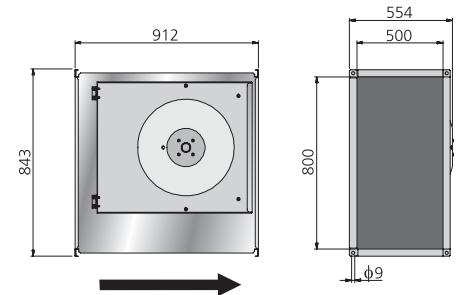

SOUND DATA

705 l/s 355 Pa	L _{pA}	L _{wA} tot dB (A)	63	125	250	500	1K	2K	4K	8K
To environment 230 V	57	64	50	59	56	58	57	52	46	37
5. Inlet 230 V		74	60	70	63	64	68	66	60	52
4. Inlet 165 V		71	58	67	61	61	65	62	56	48
3. Inlet 135 V		68	58	65	57	58	61	58	52	44
2. Inlet 110 V		64	55	61	53	53	55	52	46	36
1. Inlet 80 V		60	47	60	43	40	42	38	29	21
Outlet 230 V	79	58	73	68	72	75	70	70	63	55

General fan facts, page 34-35.

RKB 800 x 500 B3

RKB 800 x 500 D3

With backward-curved impeller and swing-out design



RKB 800 x 500 B3

PRESSURE/FLOW

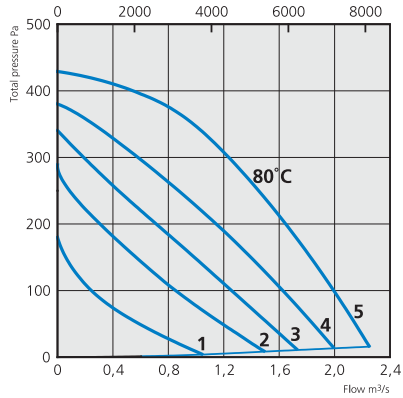

INPUT/FLOW

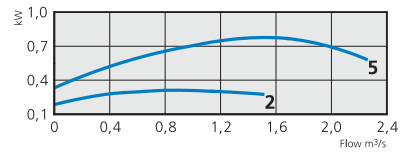

TECHNICAL DATA

Voltage, V/Hz	400/50
Current, A	1,88
Input, kW	0,78
Speed, rpm	899
Weight, kg	65
Wiring diagram	4040030
Capacitor, µF	-
Insulation class	F
Motor protection	IP 44

DIMENSIONS (mm)

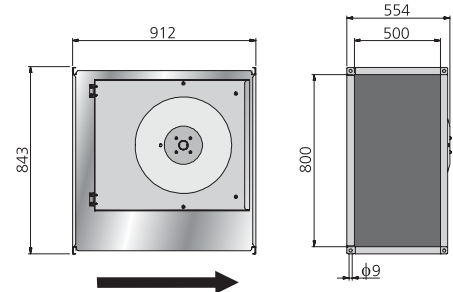

SOUND DATA

715 l/s 375 Pa	L _{pA}	L _{wA}	tot dB (A)	63	125	250	500	1K	2K	4K	8K
To environment 400 V	57	64	48	56	57	60	58	53	47	39	
5. Inlet 400 V		75	61	70	64	64	69	67	61	53	
4. Inlet 240 V		72	56	69	61	60	65	62	56	49	
3. Inlet 185 V		68	56	64	58	57	61	58	53	43	
2. Inlet 145 V		63	54	57	54	53	57	54	48	38	
1. Inlet 95 V		55	48	49	47	45	49	45	37	25	
Outlet 400 V		79	59	72	68	73	76	71	64	56	

General fan facts, page 34-35.

RKB 800 x 500 D3

PRESSURE/FLOW

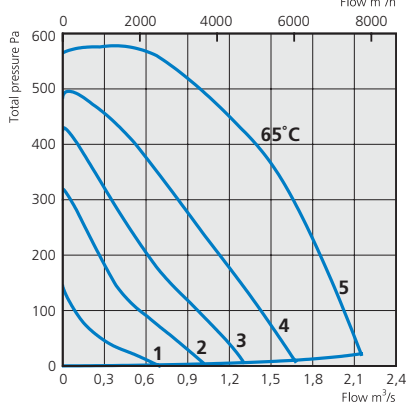

INPUT/FLOW

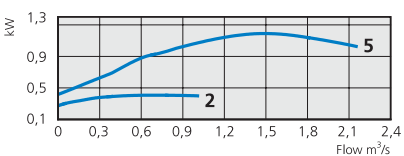

TECHNICAL DATA

Voltage, V/Hz	400/50
Current, A	2,06
Input, kW	1,18
Speed, rpm	1314
Weight, kg	65
Wiring diagram	4040004
Capacitor, µF	-
Insulation class	F
Motor protection	IP 44

DIMENSIONS (mm)

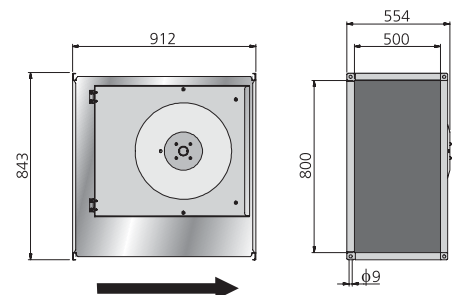

SOUND DATA

715 l/s 375 Pa	L _{pA}	L _{wA}	tot dB (A)	63	125	250	500	1K	2K	4K	8K
To environment 400 V	61	68	50	55	66	60	62	54	47	42	
5. Inlet 400 V		79	62	72	70	69	73	73	68	60	
4. Inlet 240 V		75	56	69	71	65	67	65	60	51	
3. Inlet 185 V		69	51	66	60	58	60	59	53	40	
2. Inlet 145 V		62	52	59	53	51	53	50	42	30	
1. Inlet 95 V		50	44	44	41	39	42	36	28	18	
Outlet 400 V		84	62	72	78	74	80	75	68	60	

General fan facts, page 34-35.



RKB 800 x 500 K1 RKB 800 x 500 K3

With backward-curved impellers and swing-out design

RKB 800 x 500 K1

PRESSURE/FLOW

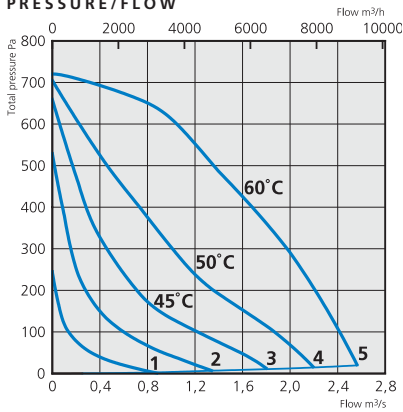

INPUT/FLOW

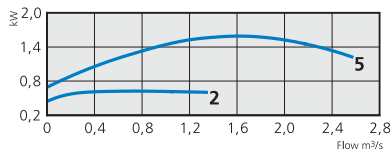

TECHNICAL DATA

Voltage, V/Hz	230/50
Current, A	7,75
Input, kW	1,61
Speed, rpm	1285
Weight, kg	57
Wiring diagram	4040001
Capacitor, μ F	25
Insulation class	F
Motor protection	IP 44

DIMENSIONS (mm)

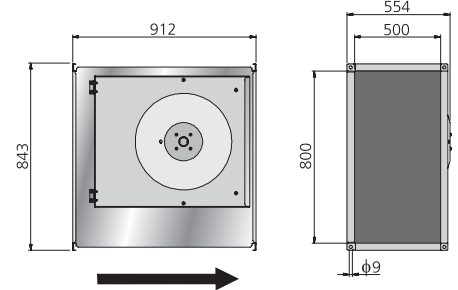

SOUND DATA

855 l/s 675Pa	L_{pA}	L_{WA} tot dB (A)	63	125	250	500	1K	2K	4K	8K
To environment 230 V	62	69	48	60	64	63	62	58	49	44
5. Inlet 230 V		80	62	73	72	68	75	74	69	61
4. Inlet 165 V		75	58	71	65	63	69	68	61	54
3. Inlet 135 V		70	55	69	59	56	62	60	54	45
2. Inlet 110 V		63	52	60	51	49	58	51	47	35
1. Inlet 80 V		54	45	53	41	38	43	40	37	30
Outlet 230 V		86	62	76	78	78	83	80	73	67

General fan facts, page 34-35.

RKB 800 x 500 K3

PRESSURE/FLOW

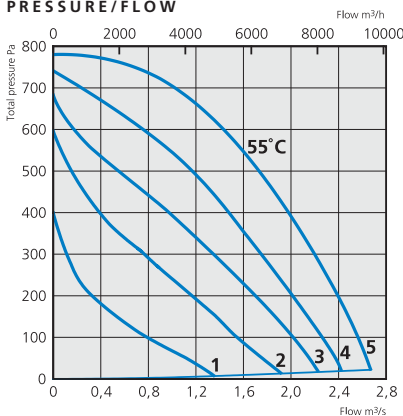

INPUT/FLOW

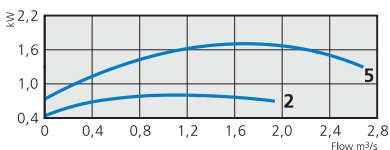

TECHNICAL DATA

Voltage, V/Hz	400/50
Current, A	3,69
Input, kW	1,72
Speed, rpm	1395
Weight, kg	58
Wiring diagram	4040030
Capacitor, μ F	-
Insulation class	F
Motor protection	IP 44

DIMENSIONS (mm)

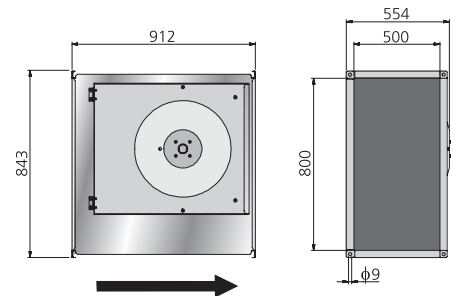

SOUND DATA

1180 l/s 665 Pa	L_{pA}	L_{WA} tot dB (A)	63	125	250	500	1K	2K	4K	8K
To environment 400 V	64	71	48	60	67	65	65	61	52	46
5. Inlet 400 V		82	62	73	76	70	77	76	71	63
4. Inlet 240 V		81	62	74	72	69	78	75	69	61
3. Inlet 185 V		76	59	71	65	64	71	69	63	56
2. Inlet 145 V		72	58	68	62	61	67	65	59	52
1. Inlet 95 V		64	57	61	54	51	57	53	47	38
Outlet 400 V		89	64	75	83	81	85	81	75	68

General fan facts, page 34-35.

RKB 1000 x 500 J1

RKB 1000 x 500 J3

With backward-curved impeller and swing-out design



RKB 1000 x 500 J1

PRESSURE/FLOW

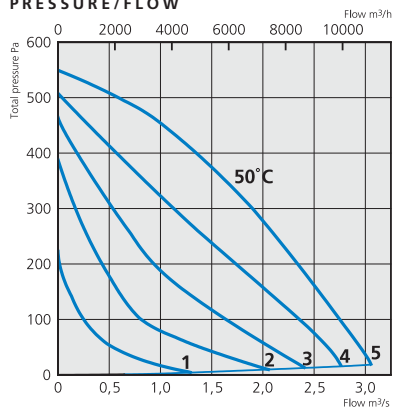

INPUT/FLOW

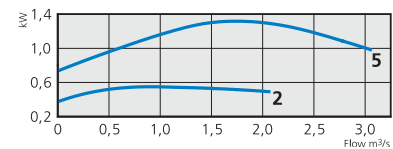

TECHNICAL DATA

Voltage, V/Hz	230/50
Current, A	6,43
Input, kW	1,32
Speed, rpm	875
Weight, kg	88
Wiring diagram	4040001
Capacitor, µF	30
Insulation class	F
Motor protection	IP 44

DIMENSIONS (mm)

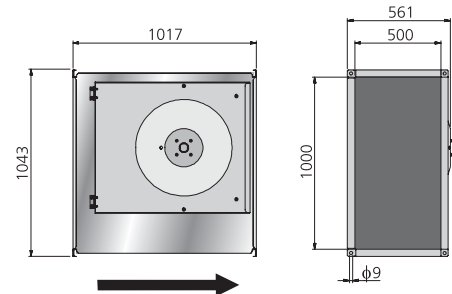

SOUND DATA

810 l/s 470 Pa	L _{pA}	L _{wA}	tot dB (A)	63	125	250	500	1K	2K	4K	8K
To environment 230 V	59	66	55	59	59	61	60	60	54	46	40
5. Inlet 230 V		76	65	73	64	67	69	67	67	62	55
4. Inlet 165 V		74	61	72	62	64	67	64	64	57	50
3. Inlet 135 V		68	58	66	56	59	61	57	57	51	42
2. Inlet 110 V		67	55	67	51	54	54	50	50	43	33
1. Inlet 80 V		58	43	58	41	43	42	42	38	28	21
Outlet 230 V		79	62	73	69	73	75	69	69	63	56

General fan facts, page 34-35.

RKB 1000 x 500 J3

PRESSURE/FLOW

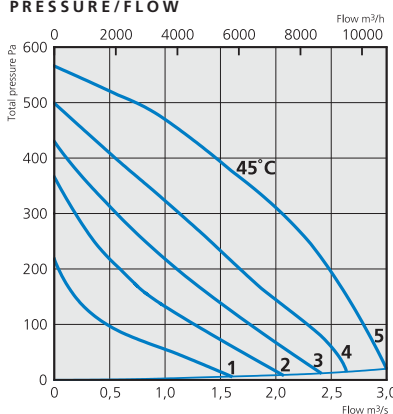

INPUT/FLOW

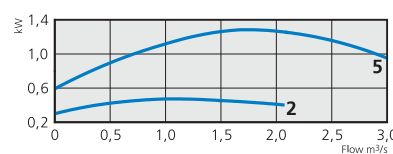

TECHNICAL DATA

Voltage, V/Hz	400/50
Current, A	3,44
Input, kW	1,28
Speed, rpm	890
Weight, kg	88
Wiring diagram	4040030
Capacitor, µF	-
Insulation class	F
Motor protection	IP 44

DIMENSIONS (mm)

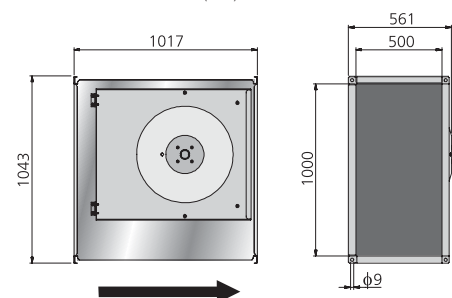

SOUND DATA

720 l/s 490 Pa	L _{pA}	L _{wA}	tot dB (A)	63	125	250	500	1K	2K	4K	8K
To environment 400 V	58	65	48	59	58	60	58	58	52	46	42
5. Inlet 400 V		76	63	72	64	67	71	69	69	63	56
4. Inlet 240 V		73	58	70	61	63	67	64	64	58	50
3. Inlet 185 V		69	57	65	58	59	63	60	60	53	45
2. Inlet 145 V		63	54	58	53	54	58	55	55	48	40
1. Inlet 95 V		54	47	49	46	46	48	44	44	37	30
Outlet 400 V		80	62	73	69	74	77	71	71	65	58

General fan facts, page 34-35.



RKB 1000 x 500 L3

With backward-curved impeller and swing-out design

RKB 1000 x 500 L3

PRESSURE/FLOW

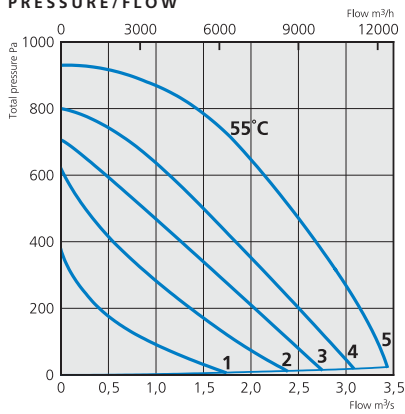

INPUT/FLOW

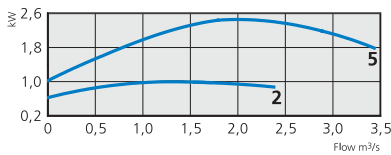

TECHNICAL DATA

Voltage, V/Hz	400/50
Current, A	4,90
Input, kW	2,46
Speed, rpm	1348
Weight, kg	80
Wiring diagram	4040030
Capacitor, µF	-
Insulation class	F
Motor protection	IP 44

DIMENSIONS (mm)

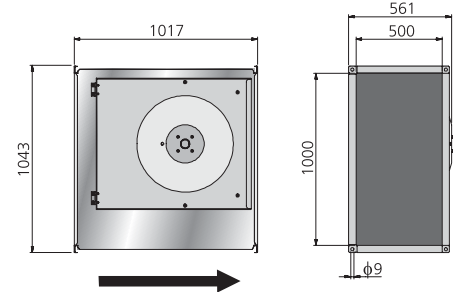

SOUND DATA

1110 l/s 840Pa	L _{pA}	L _{wA} tot dB (A)	63	125	250	500	1K	2K	4K	8K
To environment 400 V	65	72	51	63	67	65	65	60	53	47
5. Inlet 400 V		83	66	76	73	73	77	77	71	64
4. Inlet 240 V		82	61	77	71	72	76	76	68	61
3. Inlet 185 V		77	58	73	65	67	70	70	62	55
2. Inlet 145 V		74	55	70	60	69	65	64	57	49
1. Inlet 95 V		64	52	60	53	55	57	55	47	37
Outlet 400 V		89	63	77	82	81	85	80	76	69

General fan facts, page 34-35.

GENERAL FAN FACTS

DESCRIPTION

- The fan is used for transportation of “clean” air, meaning not intended for fire-dangerous substances, explosives, grinding dust, soot, etc.
- The fan is equipped with an asynchronous external rotor induction motor with maintenance-free sealed ball-bearings.
- To achieve maximum life length for installations in damp or cold environments, the fan should be operating continuously.
- The fan can be installed outside or in damp environments. Make sure that the fan-house is equipped with drainage.
- All fans are as standard, single phase 230V, 50 Hz or 3-phase 230V/400V, 50 Hz.
- The fan can be installed in any position.

INSTALLATION

- The fan must be installed according to the air direction label on the fan.
- The fan must be connected to duct or equipped with a safety grill.
- The fan should be installed in a safe way and make sure that no foreign objects are left behind.
- The fan should be installed in a way that makes service and maintenance easy. OBS! Consider the weight and size of the fan.
- The fan should be installed in a way that vibrations can be transfused to duct or building. To provide this use for example a flange.
- To regulate the speed a transformer, a speed controller or a frequency converter can be connected.
- A wiring diagram is applied on the inside of the junction box or separate enclosed.
- The fan are installed and connected electrically in the right way grounded and with motor protection.

- The motor protection must always be used, see wiring diagram.
- Electrical installations must be made by an authorised electrician.
- Electrical installations must be connected to a locally situated tension free switcher or by a lockable head switcher.

OPERATION

Before starting, make sure that:

- the current does not exceed more than +5 % of what is stated on the label.
- the connecting voltage is in between +6% to -10% of the rated voltage.
- no noise appears when starting the fan.
- the rotation direction at 3-phase motors are according to the label.

HOW TO HANDLE

- The fan must be transported in its packing until installation. This prevents transport damages, scratches and the fan from getting dirty.
- Attention, look out for sharp edges and corners.

MAINTENANCE

- Before service, maintenance or repair begins, the fan must be tension free and the impeller must have stopped.
- Consider the weight of the fan when removing or opening larger fans to avoid jamming and contusions.
- The fan must be cleaned when needed, at least once per year to maintain the capacity and to avoid unbalance which may cause unnecessary damages on the bearings.

- The fan bearings are maintenance-free and should be renewed only when necessary.
- When cleaning the fan, high-pressure cleaning or strong dissolvent must **not** be used.
- Cleaning should be done without dislodging or damaging the impeller.
- Make sure that there is no noise from the fan.

FAULT DETECTION

1. Make sure that there is tension to the fan.
2. Cut the tension and verify that the impeller is not blocked.
3. Check the thermo-contact/motor protector. If it is disconnected the cause of overheating must be taken care of, not to be repeated. To restore the manual thermo-protector the tension will be cut for a couple of minutes. Larger motors than 1,6 A may have manual resetting on the motor. If it has automatic thermo-protector the resetting will be done automatically when the motor is cold.
4. Make sure that the capacitor is connected, (single phase only) according to the wiring diagram.
5. If the fan still does not work, the first thing to do is to change the capacitor.
6. If nothing of this works, contact your fan supplier.
7. If the fan is returned to the supplier, it must be cleaned, the motor cable undamaged and a detailed nonconformity report enclosed.

WARRANTY

The warranty is only valid under condition that the fan is used according to this “Directions for use”.

Pressure/flow-curves explanation

FIG. 1:

The fan curve describes the capacity of the fan, i.e. the fan's flow at different pressures at a certain input voltage.

The fan diagram has the pressure in Pascal, Pa, on the vertical axis and the flow in cubic meters per second, m³/s, on the horizontal axis.

The point on the fan curve showing the current pressure and flow is called the fan's working point. In our example it is marked with P.

If the pressure increases in the ducts, the working point moves along the fan curve and hence a lower flow is obtained. In the example the working point would move from P1 to P2.

FIG. 2:

The system line describes the total behaviour of a ventilation system (ducts, silencers and valves etc.).

Along this system line, S, the working point is moved from P2 to P3 as the rotational speed is changed.

Discrete voltage steps with eg. a transformer produces different fan curves, transformer curves, indicated in the example.

FIG. 3:

Our fan curves presents the total pressure in Pascal. Total pressure = Static + Dynamic pressure.

The static pressure is the fan's pressure compared to the atmospheric pressure. It is

FIG. 1:

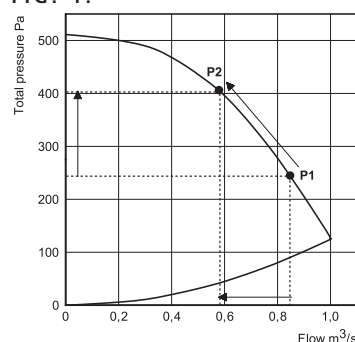

this pressure that shall overcome the pressure losses of the ventilation system.

The dynamic pressure is a calculated pressure that arises at the outlet of the fan, and is mostly due to air velocity. The dynamic pressure thus describes how the fan is working. The dynamic pressure is presented with a curve, starting at origo, that increases with increased flow. A high dynamic pressure can with wrong duct dimensions produce a high pressure loss. If the pressure loss in the system is known, a fan whose difference between the total and the dynamic pressure corresponds to the pressure loss in the system must be found.

FIG. 2:

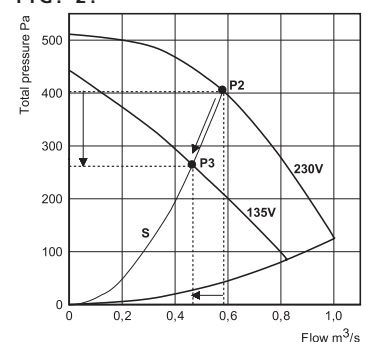
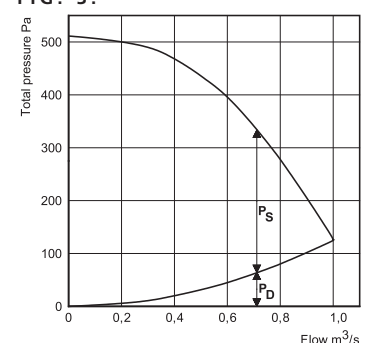

FIG. 3:



Sound data explanation

SOUND DATA IN THIS BROCHURE IS BASED ON FOLLOWING DEFINITIONS:

The points for which the sound data is presented are along the system line defined by the pressure and flow stated in the sound data table for each fan. There are three types of sound in these tables; inlet- and outlet sound are measured in duct, while the surrounding sound is measured outside the fan and duct system. For all these types of sound, the sound power levels are presented in octave bands. For the surrounding sound, also the sound pressure level has been calculated.

THE SOUND POWER LEVEL

The sound power level, $L_w(A)$ is used to calculate the sound from the whole ventilation system. This system can be a composition of grilles, dampers and diffusers for example.

The sound power level is a measured value according to standards, and it does not tell how the sound appears as the sound power is independent of the characteristics of the placement of the fan. In order to resemble the human ear, the A-filter is used indicated with $L_w(A)$ measured in dB(A).

THE SOUND PRESSURE LEVEL

The sound pressure level, L_p or $L_p(A)$, tells how the human ear registers the sound. It is dependent on the sound power level, distance from the source, restrictions of the propagation and the acoustic characteristics of the room.

The sound pressure level is presented for a room with an equivalent absorption area of 20 m^2 . 7 dB difference correspond to a distance of ca 3 m, where the sound is emitted in a semi spherical propagation.

The sound pressure level can be calculated as:
 $L_p = L_w + 10 \log(Q/4\pi r^2 + 4/A)$

A = is the room's equivalent absorption area

Q = is the propagation type:

$Q=1$ is spherical propagation

$Q=2$ is semi spherical propagation

$Q=4$ is quarter spherical propagation.

For the free field case, i.e. from a roof fan, the sound pressure level is calculated as:

$L_p = L_w + 10 \log Q/4\pi r^2$

With $L_w(A)$ tot at 63dB(A), a distance of 5 meters, semi spherical propagation and free field case, the result will be:

$L_p(A) = 63 + 10 \log 2/4\pi 5^2 = 63 - 22 = 41 \text{ dB(A)}$

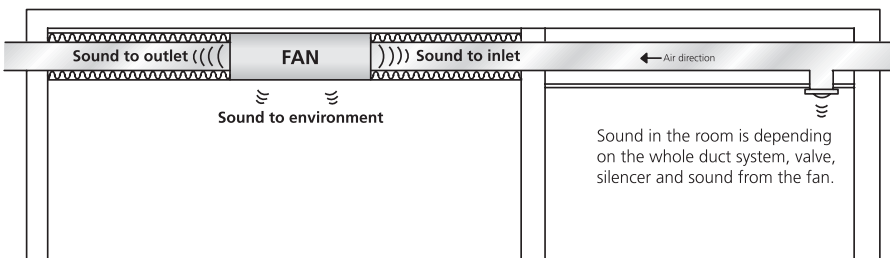

Temperature of transported air

In pressure/flow diagrams or in the table of technical data there are facts about highest temperature of transported air.

All motors have insulation class F which means that the thermal contact disconnect the power when the winding temperature is maximum 155°C . At this winding temperature the life of the ball bearings is not optimum. This is why the ambient temperature is shown at a lower winding temperature so the life of ball bearings become optimum.

Observe that all 3-phase motors needs an external thermal contact relay connected to the outdrawn thermal contact wires. This is really important at speed control

Forward curved impeller: The dashed part of the curve in the pressure/flow diagrams indicates the area where the winding temperature get too high, even at low air temperatures and is hence a forbidden area. In the diagrams the variations in size of the restricted area is dependent on differences in power/current consumption.

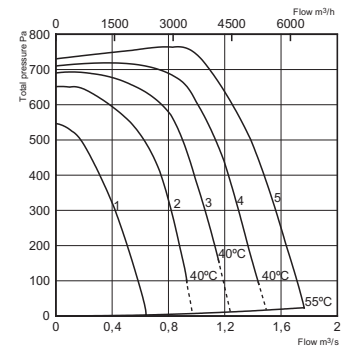

Wiring diagrams

4040001 Single phase

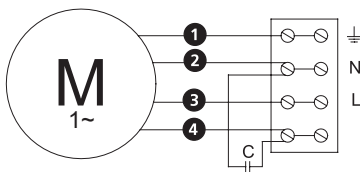

- (M1) = Fan Motor
- (M2) = Fan Motor
- (M3) = Rotor Motor
- 1 = Yellow/Green
- 2 = Black
- 3 = Blue
- 4 = Brown
- 5 = White (TW)
- 6 = Orange
- 7 = Grey
- 8 = Red

4040004 3-phase Y 400 V external thermo-contact leads, TW

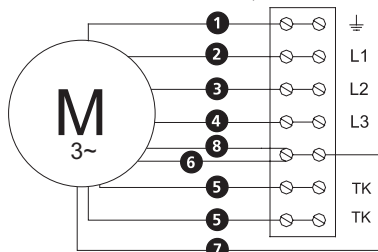

4040005 Single phase external thermo-contact leads, TW

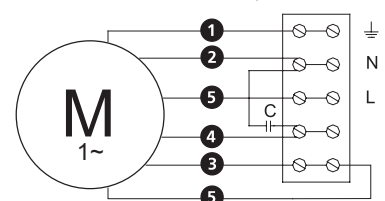

4040030 3-phase Y 400 V external thermo-contact leads, TW

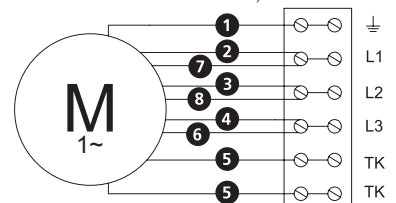



ÖSTBERG - THE FAN COMPANY

Östberg – The Fan Company is one of leading producers of centrifugal in-line duct fans in the world.

30 years ago the founder and owner was one of them who invented the first centrifugal in-line duct fan in the history.

We have continued to develop new products and today we offer a wide product range of centrifugal in-line duct fans.

Our goal has always been to offer quality products at competitive prices.

Fresh air from

ÖSTBERG
THE FAN COMPANY 

AB C.A. Östberg
Industrigatan 2, S-774 35 Avesta, Sweden
Tel: +46 226 860 00
Fax: +46 226 860 05
E-mail: info@ca-ostberg.se
www.ostberg.com